



Quotation Advert

Opening Date: 2019-10-09 
Closing Date: 2019-10-17 
Closing Time: 11:00

INSTITUTION DETAILS



Institution Name: Charles James hospital (SANTA) 
Province: KwaZulu-Natal
Department or Entity: Department of Health
Division or section: Central Supply Chain Management
Place where goods / services is required: CHARLES JAMES HOSPITAL
Date Submitted: 2019-10-08 

ITEM CATEGORY AND DETAILS

Quotation Number: ZNQ:
164/19/20
Item Category: Select... 
Item Description: Replace Submissive Sewer Pump with Waste Sewer Water Pump.
Horizontal Waste Water Pump with Belt Drive

Quantity (if supplies) 2 UNITS

COMPULSORY BRIEFING SESSION / SITE VISIT

Select Type: Not Applicable 
Date : N/A 
Time:
Venue:

QUOTES CAN BE COLLECTED FROM: CHARLES JAMES HOSPITAL 
No 6 SOMPUKANE ROAD

QUOTES SHOULD BE DELIVERED TO: TENDER BOX - AT CHARLES JAMES HOSPITAL

ENQUIRIES REGARDING THE ADVERT MAY BE DIRECTED TO:

Name: Themba Dlamini
Email: mandla.mtshali@kznhealth
Contact Number:

031 905 4222/2

Finance Manager Name:

Finance Manager Signature:



STANDARD QUOTE DOCUMENTATION OVER R30 000.00

YOU ARE HEREBY INVITED TO QUOTE FOR REQUIREMENTS AT: CHARLES JAMES HOSPITAL
DATE ADVERTISED: 09-10-2019
PHYSICAL ADDRESS: No. 6 SOMPUKANE ROAD EZIMBOKODWENI 4125

ZNQ NUMBER: 164/19/20 CLOSING DATE: 17-10-2019 CLOSING TIME: 11:00

DESCRIPTION: REPLACE 2 X SUBMISIVE SEWER PUMPS WITH WASTE WATER PUMP

CONTRACT PERIOD: ONCE OFF VALIDITY PERIOD 60 Days

SARS PIN:

CENTRAL SUPPLIER DATABASE REGISTRATION (CSD) NO. []

UNIQUE REGISTRATION REFERENCE []

DEPOSITED IN THE QUOTE BOX SITUATED AT (STREET ADDRESS)
No. 6 SOMPUKANE ROAD EZIMBOKODWENI
4125

Bidders should ensure that quotes are delivered timeously to the correct address. If the quote is late, it will not be accepted for consideration.

The quote box is open from 08:00 to 15:30.

ALL QUOTES MUST BE SUBMITTED ON THE OFFICIAL FORMS – (NOT TO BE RE-TYPED)

THIS QUOTE IS SUBJECT TO THE PREFERENTIAL PROCUREMENT POLICY FRAMEWORK ACT AND THE PREFERENTIAL PROCUREMENT REGULATIONS, 2011, THE GENERAL CONDITIONS OF CONTRACT (GCC) AND, IF APPLICABLE, ANY OTHER SPECIAL CONDITIONS OF CONTRACT.

THE FOLLOWING PARTICULARS MUST BE FURNISHED
(FAILURE TO DO SO WILL RESULT IN YOUR QUOTE BEING DISQUALIFIED)

NAME OF BIDDER
POSTAL ADDRESS
STREET ADDRESS
TELEPHONE NUMBER CODE.....NUMBER..... FACSIMILE NUMBER CODENUMBER.....
CELLPHONE NUMBER
E-MAIL ADDRESS
VAT REGISTRATION NUMBER (If VAT vendor)

HAS A B-BBEE STATUS LEVEL VERIFICATION CERTIFICATE BEEN SUBMITTED? (SBD 6.1) [YES] [NO]

IF YES, WHO WAS THE CERTIFICATE ISSUED BY? [TICK APPLICABLE BOX]

AN ACCOUNTING OFFICER AS CONTEMPLATED IN THE CLOSE CORPORATION ACT (CCA)
A VERIFICATION AGENCY ACCREDITED BY THE SOUTH AFRICAN ACCREDITATION SYSTEM (SANAS);
A REGISTERED AUDITOR.....
[A B-BBEE STATUS LEVEL VERIFICATION CERTIFICATE/SWORN AFFIDAVIT (FOR EMEs& QSEs) MUST BE SUBMITTED IN ORDER TO QUALIFY FOR PREFERENCE POINTS FOR B-BBEE]

[YES] [NO]

CHARLES JAMES HOSPITAL SAMPLE PICTURE FOR
WATER SEWER PUMP
ZNQ 164/19/20



PUMP SPECIFICATIONS

Size: 4" x 4" (101 mm x 101 mm) NPT - Female.
Casing: Gray Iron 30.
Maximum Operating Pressure 86 psi (593 kPa).
Semi-Open Type, Two Vane Impeller: Ductile Iron 65-45-12.
Handles 3" (76.2 mm) Diameter Spherical Solids.
Impeller Shaft: Alloy Steel 4130.
Shaft Sleeve: Alloy Steel 4130.
Replaceable Wear Plate: Carbon Steel 1015.
Removable Cover Plate: Gray Iron 30; 37 lbs. (17 kg).
Bearing Housing: Gray Iron 30.
Seal Plate: Gray Iron 30.
Flap Valve: Neoprene w/Steel Reinforcing.
Radial Bearing: Open Single Row Ball.
Thrust Bearing: Open Double Row Ball.
Bearing and Seal Cavity Lubrication: SAE 30 Non-Detergent Oil.
Flanges: 125# Gray Iron 30.
Gaskets: Buna-N w/Compressed Synthetic Fibers, Vegetable Fiber, PTFE, Cork and Rubber.
O-Rings: Buna-N.
Hardware: Standard Plated Steel.
Brass Pressure Relief Valve.
Bearing Cavity Oil Level Sight Gauge.
Optional Equipment: Stainless Steel 316 Pressure Relief Valve.
Automatic Air Release Valve. G-R Hard Iron Impeller, Seal Plate and Wear Plate. 120V/240V Casing Heater. High Pump Temperature Shutdown Kit. Self-Cleaning Wear Plate.
Gray Iron 30 Suction and Discharge Spool Flanges:
4" ASA (Specify Model T4A3-B /F).
100 mm DIN 2527 (PN 16) (Specify Model T4A3-B /FM).
*Consult Factory for Applications Exceeding Maximum Pressure and/or Temperature Indicated.



Shown with Optional Suction & Discharge Spool Flanges (Available in ASA or DIN Standard Sizes).

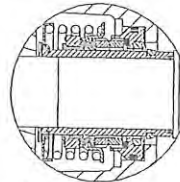
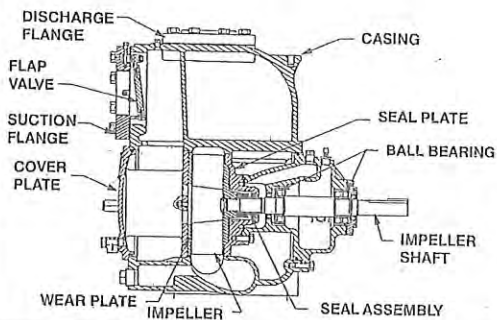

SEAL DETAIL

Cartridge Type, Mechanical, Oil-Lubricated, Double Floating, Self-Aligning. Tungsten Titanium Carbide Rotating and Stationary Faces. Stainless Steel 316 Stationary Seal. Fluorocarbon Elastomers (DuPont Viton[®] or Equivalent). Stainless Steel 18-8 Cage and Spring. Maximum Temperature of Liquid Pumped, 160°F (71°C).*

ARE YOU THE ACCREDITED REPRESENTATIVE IN SOUTH AFRICA FOR THE GOODS / SERVICES / WORKS OFFERED? [IF YES ENCLOSE PROOF]

OFFICIAL PRICE PAGE FOR QUOTATIONS

SIGNATURE OF BIDDER DATE.....
 [By signing this document I hereby agree to all terms and conditions]

CAPACITY UNDER WHICH THIS QUOTE IS SIGNED.....

Item No	Quantity	Description	Brand & model	Country of manufacture	Price	
					R	c
	2 UNITS	REPLACE 2 X SUBMISSIVE SEWER PUMPS				
		WITH WASTE SEWER WATER PUMP				
		HORIZONTAL WASTE WATER PUMP				
		WITH BELT DRIVE				
		PLEASE REFER TO THE ATTACHED				
		SPECIFICATION				
	NOTE:	UNIQUE REGISTRATION NUMBERS				
		AND CSD REGISRATION NUMBER MUST BE				
		PRINTED CLEARLY				
VALUE ADDED TAX @ 14% (Only if VAT Vendor)						
TOTAL QUOTATION PRICE (VALIDITY PERIOD 60 Days)						

Does This Offer Comply With The Specification?	Does The Article Conform To The S.A.N.S. / S.A.B.S. Specification?
Is The Price Firm?	State Delivery Period E.G. <i>E.G. 1day, 1week</i>

Enquiries regarding the quote may be directed to: Contact Person: THEMBA DLAMINI Tel: 0319054222/3	Enquiries regarding technical information may be directed to: Contact Person: MANDLA MTSHALI Tel: 0319054222/3
---	---

DECLARATION OF INTEREST

1. Any legal person, including persons employed by the state¹, or persons having a kinship with persons employed by the state, including a blood relationship, may make an offer or offers in terms of this invitation to quote (includes a price quotation, advertised competitive quote, limited quote or proposal). In view of possible allegations of favouritism, should the resulting quote, or part thereof, be awarded to persons employed by the state, or to persons connected with or related to them, it is required that the bidder or his/her authorised representative declare his/her position in relation to the evaluating/adjudicating authority where-
 - the bidder is employed by the state; and/or
 - the legal person on whose behalf the bidding document is signed, has a relationship with persons/a person who are/is involved in the evaluation and or adjudication of the quote(s), or where it is known that such a relationship exists between the person or persons for or on whose behalf the declarant acts and persons who are involved with the evaluation and or adjudication of the quote.
2. In order to give effect to the above, the following questionnaire must be completed and submitted with the quote.

- | | |
|--|---|
| 2.1. Full Name of bidder/representative..... | 2.4. Company Registration Number: |
| 2.2. Identity Number: | 2.5. Tax Reference Number: |
| 2.3. Position occupied in the Company (director, trustee, shareholder) ² :..... | 2.6. VAT Registration Number: |

2.7. The names of all directors / trustees / shareholders / members, their individual identity numbers, tax reference numbers and, if applicable, employee / persal numbers must be indicated in paragraph 3 below. [TICK APPLICABLE]

2.8. Are you or any person connected with the bidder presently employed by the state? YES NO

2.8.1. If so, furnish the following particulars:
 Name of person / director / trustee / shareholder/ member:
 Name of state institution at which you or the person connected to the bidder is employed:.....
 Position occupied in the state institution:Any other particulars:.....

2.8.2. If you are presently employed by the state, did you obtain the appropriate authority to undertake remunerative work outside employment in the public sector? YES NO

2.8.2.1. If yes, did you attach proof of such authority to the quote document?

(Note: Failure to submit proof of such authority, where applicable, may result in the disqualification of the quote.)

2.8.2.2. If no, furnish reasons for non-submission of such proof:

2.9. Did you or your spouse, or any of the company's directors / trustees / shareholders / members or their spouses conduct business with the state in the previous twelve months? YES NO

2.9.1. If so, furnish particulars:.....

2.10. Do you, or any person connected with the bidder, have any relationship (family, friend, other) with a person employed by the state and who may be involved with the evaluation and or adjudication of this quote? YES NO

2.10.1. If so, furnish particulars:.....

2.11. Are you, or any person connected with the bidder, aware of any relationship (family, friend, other) between any other bidder and any person employed by the state who may be involved with the evaluation and or adjudication of this quote? YES NO

2.11.1. If so, furnish particulars:.....

2.12. Do you or any of the directors / trustees / shareholders / members of the company have any interest in any other related companies whether or not they are bidding for this contract? YES NO

2.12.1. If so, furnish particulars:.....

3. Full details of directors / trustees / members / shareholders.

NB: The Department Of Health will validate **details of directors / trustees / members / shareholders** on CSD. It is the suppliers' responsibility to ensure that their details are up-to-date and verified on CSD. If the Department cannot validate the **information** on CSD, the quote will not be considered and passed over as non-compliant according to National Treasury Instruction Note 4 (a) 2016/17.

4 DECLARATION

I, THE UNDERSIGNED (NAME).....CERTIFY THAT THE INFORMATION FURNISHED IN PARAGRAPHS 2.

I ACCEPT THAT THE STATE MAY REJECT THE QUOTE OR ACT AGAINST ME SHOULD THIS DECLARATION PROVE TO BE FALSE.

..... Name of bidder Signature Position Date
-------------------------	--------------------	-------------------	---------------

¹"State" means –

- | | |
|---|---|
| a) any national or provincial department, national or provincial public entity or constitutional institution within the meaning of the Public Finance Management Act, 1999 (Act No. 1 of 1999); | c) provincial legislature; |
| b) any municipality or municipal entity; | d) national Assembly or the national Council of provinces; or |
| | e) Parliament. |

²"Shareholder" means a person who owns shares in the company and is actively involved in the management of the enterprise or business and exercises control over the enterprise.

SPECIAL CONTRACT CONDITIONS OF QUOTATIONS

1. AMENDMENT OF CONTRACT

1.1. Any amendment to or renunciation of the provisions of the contract shall at all times be done in writing and shall be signed by both parties.

2. CHANGE OF ADDRESS

2.1. Bidders must advise the Department of Health (institution where the offer was submitted) should their address (*domicilium citandi et executandi*) details change from the time of bidding to the expiry of the contract.

3. GENERAL CONDITIONS ATTACHED TO THIS QUOTATION

- 3.1. The institution is under no obligation to accept the lowest or any quote.
- 3.2. The price quoted must include VAT (if VAT vendor). However, it must be noted that the department reserves the right to evaluate all quotations excluding VAT as some bidders may not be VAT vendors.
- 3.3. The bidder must ensure the correctness & validity of quote:
 - (i) *that the price(s), rate(s) & preference quoted cover all for the work/item (s) & accept that any mistakes regarding the price (s) & calculations will be at the bidder's risk*
- 3.4. The bidder must accept full responsibility for the proper execution & fulfilment of all obligations conditions devolving on under this agreement, as the Principal (s) liable for the due fulfilment of this contract.
- 3.5. This quotation will be evaluated based on the 80/20 points system, specification & correctness of information. All required documentation must be completed in full and submitted.
- 3.6. Offers must comply strictly with the specification.
- 3.7. Only offers that meet or are greater than the specification will be considered.
- 3.8. Late quotes will not be considered.
- 3.9. Expired product/s will not be accepted. All products supplied must be valid for a minimum period of six months.
- 3.10. A bidder not registered on the Central Suppliers Database or verification has failed will not be considered.
- 3.11. All delivery costs must be included in the quote price, for delivery at the prescribed destination.
- 3.12. Only firm prices will be accepted. Such prices must remain firm for the contract period. Non-firm prices (including rates of exchange variations) will not be considered.
- 3.13. In cases where different delivery points influence the pricing, a separate pricing schedule must be submitted for each delivery point.
- 3.14. In the event of a bidder having multiple quotes, only the cheapest according to specification will be considered. Furthermore a verification will be done to identify if bidders have multiple companies and are quoting (cover-quoting) for this bid. In such instances only the cheapest bid according to specification will be considered.

4. SAMPLES

- 4.1. In the case of the quote document stipulating that samples are required, the supplier will be informed in due course when samples should be provided to the institution. (This decreases the time of safety and storage risk that may be incurred by the respective institution). The bidders sample will be retained if such bidder wins the contract.
 - (i) If a company/s who has not won the quote requires their samples, they must advise the institution in writing of such.
 - (ii) If samples are not collected within three months of close of quote the institution reserves the right to dispose of them at their discretion.
- 4.2. **Samples must be made available when requested in writing or if stipulated on the document.**
 - (i) If a Bidder fails to provide a sample of their product on offer for scrutiny against the set specification when requested, their offer will be rejected. All testing will be for the account of the bidder.

5. COMPULSORY SITE INSPECTION / BRIEFING SESSION

5.1. Bidders who fail to attend the compulsory meeting will be disqualified from the evaluation process.

- (i) The institution has determined that a compulsory site meeting NO take place
- (ii) Date / / Time : Place / / /

Institution Stamp:	Institution Site Inspection / briefing session Official Full Name: Signature: Date:
--------------------	--

6. STATEMENT OF SUPPLIES AND SERVICES

- 6.1. The contractor shall, when requested to do so, furnish particulars of supplies delivered or services executed. If he/she fails to do so, the Department may, without prejudice to any other rights which it may have, institute inquiries at the expense of the contractor to obtain the required particulars.

7. SUBMISSION AND COMPLETION OF SBD 6.1

- 7.1. Should a bidder wish to qualify for preference points they must complete a SBD 6.1 document. Failure by a bidder to provide all relevant information required, will result in such a bidder not being considered for preference point's allocation. The preferences applicable on the closing date will be utilized. Any changes after the closing date will not be considered for that particular quote.

8. TAX COMPLIANCE REQUIREMENTS

- 8.1. In the event that the tax compliance status has failed on CSD, *it is the suppliers' responsibility to provide a SARS pin in order for the institution to validate the tax compliance status of the supplier.*
- 8.2. In the event that the institution cannot validate the suppliers' tax clearance on SARS as well as the Central Suppliers Database, *the quote will not be considered and passed over as non-compliant according to National Treasury Instruction Note 4 (a) 2016/17.*

9. TAX INVOICE

- 9.1. A tax invoice shall be in the currency of the Republic of South Africa and shall contain the following particulars:

- (i) the name, address and registration number of the supplier;
- (ii) the name and address of the recipient;
- (iii) an individual serialized number and the date upon which the tax invoice is issued;
- (iv) a description and quantity or volume of the goods or services supplied;
- (v) the official department order number issued to the supplier;
- (vi) the value of the supply, the amount of tax charged;
- (vii) the words tax invoice in a prominent place.

10. PATENT RIGHTS

- 10.1. The supplier shall indemnify the **KZN Department of Health** (hereafter known as the purchaser) against all third-party claims of infringement of patent, trademark, or industrial design rights arising from use of the goods or any part thereof by the purchaser.

11. PENALTIES

- 11.1. If the supplier fails to deliver any or all of the goods or to perform the services within the period(s) specified in the contract, the purchaser shall, without prejudice to its other remedies under the contract, deduct from the contract price, as a penalty, a sum calculated on the delivered price of the delayed goods or unperformed services using the current prime interest rate calculated for each day of the delay until actual delivery or performance. The purchaser may also consider termination of the contract.

12. TERMINATION FOR DEFAULT

- 12.1. The purchaser, without prejudice to any other remedy for breach of contract, by written notice of default sent to the supplier, may terminate this contract in whole or in part:
- (i) if the supplier fails to deliver any or all of the goods within the period(s) specified in the contract,
 - (ii) if the supplier fails to perform any other obligation(s) under the contract; or
 - (iii) if the supplier, in the judgment of the purchaser, has engaged in corrupt or fraudulent practices in competing for or in executing the contract.
- 12.2. In the event the purchaser terminates the contract in whole or in part, the purchaser may procure, upon such terms and in such manner as it deems appropriate, goods, works or services similar to those undelivered, and the supplier shall be liable to the purchaser for any excess costs for such similar goods, works or services.
- 12.3. Where the purchaser terminates the contract in whole or in part, the purchaser may decide to impose a restriction penalty on the supplier by prohibiting such supplier from doing business with the public sector for a period not exceeding 10 years.

FAILURE TO COMPLY WITH ABOVE WILL RESULT IN YOUR QUOTE BEING PASSED OVER.

PREFERENCE POINTS CLAIM FORM IN TERMS OF THE PREFERENTIAL PROCUREMENT REGULATIONS 2017

This preference form must form part of all quotes invited. It contains general information and serves as a claim form for preference points for Broad-Based Black Economic Empowerment (B-BBEE) Status Level of Contribution

NB: BEFORE COMPLETING THIS FORM, BIDDERS MUST STUDY THE GENERAL CONDITIONS, DEFINITIONS AND DIRECTIVES APPLICABLE IN RESPECT OF B-BBEE, AS PRESCRIBED IN THE PREFERENTIAL PROCUREMENT REGULATIONS, 2017.

1. GENERAL CONDITIONS

1.1 The following preference point systems are applicable to all quotes:

- the 80/20 system for requirements with a Rand value of up to R50 000 000 (all applicable taxes included); and

1.2 The value of this quote is estimated to not exceed R50 000 000 (all applicable taxes included) and therefore the 80/20 preference point system shall be applicable.

1.3 Points for this quote shall be awarded for:

- (a) Price; and
- (b) B-BBEE Status Level of Contributor.

1.4 The maximum points for this quote is allocated as follows:

	POINTS
PRICE	80
B-BBEE STATUS LEVEL OF CONTRIBUTOR	20
Total points for Price and B-BBEE must not exceed	100

1.5 Failure on the part of a bidder to submit proof of B-BBEE Status level of contributor together with the quote, will be interpreted to mean that preference points for B-BBEE status level of contribution are not claimed.

1.6 The purchaser reserves the right to require of a bidder, either before a quote is adjudicated or at any time subsequently, to substantiate any claim in regard to preferences, in any manner required by the purchaser.

2. DEFINITIONS

- (a) "B-BBEE" means broad-based black economic empowerment as defined in section 1 of the Broad-Based Black Economic Empowerment Act;
- (b) "B-BBEE status level of contributor" means the B-BBEE status of an entity in terms of a code of good practice on black economic empowerment, issued in terms of section 9(1) of the Broad-Based Black Economic Empowerment Act;
- (c) "bid" means a written offer in a prescribed or stipulated form in response to an invitation by an organ of state for the provision of goods or services, through price quotations, advertised competitive bidding processes or proposals;
- (d) "Broad-Based Black Economic Empowerment Act" means the Broad-Based Black Economic Empowerment Act, 2003 (Act No. 53 of 2003);
- (e) "EME" means an Exempted Micro Enterprise in terms of a code of good practice on black economic empowerment issued in terms of section 9 (1) of the Broad-Based Black Economic Empowerment Act;
- (f) "functionality" means the ability of a tenderer to provide goods or services in accordance with specifications as set out in the tender documents.
- (g) "prices" includes all applicable taxes less all unconditional discounts;
- (h) "proof of B-BBEE status level of contributor" means:
 - 1) B-BBEE Status level certificate issued by an authorized body or person;
 - 2) A sworn affidavit as prescribed by the B-BBEE Codes of Good Practice;
 - 3) Any other requirement prescribed in terms of the B-BBEE Act;
- (i) "QSE" means a qualifying small business enterprise in terms of a code of good practice on black economic empowerment issued in terms of section 9 (1) of the Broad-Based Black Economic Empowerment Act;
- (j) "rand value" means the total estimated value of a contract in Rand, calculated at the time of bid invitation, and includes all applicable taxes;

3. POINTS AWARDED FOR PRICE

3.1 THE 80/20 PREFERENCE POINT SYSTEMS

A maximum of 80 points is allocated for price on the following basis:

$$Ps = 80 \left(1 - \frac{Pt - P \text{ min}}{P \text{ min}} \right) \text{ Where}$$

- Ps = Points scored for price of bid under consideration
- Pt = Price of bid under consideration
- Pmin = Price of lowest acceptable bid

4. POINTS AWARDED FOR B-BBEE STATUS LEVEL OF CONTRIBUTOR

4.1 In terms of Regulation 6 (2) and 7 (2) of the Preferential Procurement Regulations, preference points must be awarded to a bidder for attaining the B-BBEE status level of contribution in accordance with the table below:

B-BBEE Status Level of Contributor	Number of points (80/20 system)
1	20
2	18
3	14
4	12
5	8
6	6
7	4
8	2
Non-compliant contributor	0

5. BID DECLARATION

5.1 Bidders who claim points in respect of B-BBEE Status Level of Contribution must complete the following:

6. B-BBEE STATUS LEVEL OF CONTRIBUTOR CLAIMED IN TERMS OF PARAGRAPHS 1.4 AND 4.1

6.1 B-BBEE Status Level of Contributor: =(maximum of 20 points)

(Points claimed in respect of paragraph 7.1 must be in accordance with the table reflected in paragraph 4.1 and must be substantiated by relevant proof of B-BBEE status level of contributor.

7. SUB-CONTRACTING

(Tick applicable box)

7.1 Will any portion of the contract be sub-contracted?

YES	<input type="checkbox"/>	NO	<input type="checkbox"/>
-----	--------------------------	----	--------------------------

7.1.1 If yes, indicate:

- i) What percentage of the contract will be subcontracted.....%
- ii) The name of the sub-contractor.....
- iii) The B-BBEE status level of the sub-contractor.....

8. Whether the sub-contractor is an EME or QSE

(Tick applicable box)

iv) Specify, by ticking the appropriate box, if subcontracting with an enterprise in terms of Preferential Procurement Regulations,2017:

YES	<input type="checkbox"/>	NO	<input type="checkbox"/>
-----	--------------------------	----	--------------------------

Designated Group: An EME or QSE which is at last 51% owned by:	EME √	QSE √
Black people	<input type="checkbox"/>	<input type="checkbox"/>
Black people who are youth	<input type="checkbox"/>	<input type="checkbox"/>
Black people who are women	<input type="checkbox"/>	<input type="checkbox"/>
Black people with disabilities	<input type="checkbox"/>	<input type="checkbox"/>
Black people living in rural or underdeveloped areas or townships	<input type="checkbox"/>	<input type="checkbox"/>
Cooperative owned by black people	<input type="checkbox"/>	<input type="checkbox"/>
Black people who are military veterans	<input type="checkbox"/>	<input type="checkbox"/>
OR		
Any EME	<input type="checkbox"/>	<input type="checkbox"/>
Any QSE	<input type="checkbox"/>	<input type="checkbox"/>

9. DECLARATION WITH REGARD TO COMPANY/FIRM

9.1 Name of company/firm:.....

9.2 VAT registration number:.....

9.3 Company registration number:.....

9.4 TYPE OF COMPANY/ FIRM [TICK APPLICABLE BOX]

- Partnership/Joint Venture / Consortium
- One person business/sole propriety
- Close corporation
- Company
- (Pty) Limited

9.5 DESCRIBE PRINCIPAL BUSINESS ACTIVITIES

.....
.....

9.6 COMPANY CLASSIFICATION [TICK APPLICABLE BOX]

- Manufacturer
- Supplier
- Professional service provider
- Other service providers, e.g. transporter, etc.

9.7 Total number of years the company/firm has been in business:.....

9.8 I/we, the undersigned, who is / are duly authorised to do so on behalf of the company/firm, certify that the points claimed, based on the B-BBE status level of contributor indicated in paragraphs 1.4 and 6.1 of the foregoing certificate, qualifies the company/ firm for the preference(s) shown and I / we acknowledge that:

- i) The information furnished is true and correct;
- ii) The preference points claimed are in accordance with the General Conditions as indicated in paragraph 1 of this form;
- iii) In the event of a contract being awarded as a result of points claimed as shown in paragraphs 1.4 and 6.1, the contractor may be required to furnish documentary proof to the satisfaction of the purchaser that the claims are correct;
- iv) If the B-BBEE status level of contributor has been claimed or obtained on a fraudulent basis or any of the conditions of contract have not been fulfilled, the purchaser may, in addition to any other remedy it may have –
 - (a) disqualify the person from the bidding process;
 - (b) recover costs, losses or damages it has incurred or suffered as a result of that person's conduct;
 - (c) cancel the contract and claim any damages which it has suffered as a result of having to make less favourable arrangements due to such cancellation;
 - (d) recommend that the bidder or contractor, its shareholders and directors, or only the shareholders and directors who acted on a fraudulent basis, be restricted by the National Treasury from obtaining business from any organ of state for a period not exceeding 10 years, after the *audi alteram partem* (hear the other side) rule has been applied; and
 - (e) forward the matter for criminal prosecution.

WITNESSES	
1.
2.

..... SIGNATURE(S) OF BIDDERS(S)
DATE:
ADDRESS.....