





Quotation Advert

Opening Date: 2020-07-21 
Closing Date: 2020-07-28 
Closing Time: 11:00

INSTITUTION DETAILS



Institution Name: Head Office Quotations 
Province: KwaZulu-Natal
Department or Entity: Department of Health
Division or section: Central Supply Chain Management
Place where goods / services is required Infrastructure Development
Date Submitted 2020-07-20 

ITEM CATEGORY AND DETAILS

Quotation Number: ZNQ:
323/20/21-H
Item Category: Services 
Item Description: Replacement of faulty body cabinets by walk in cold room at Howick Forensic Mortuary

Quantity (if supplies) 1

COMPULSORY BRIEFING SESSION / SITE VISIT

Select Type: Compulsory Site Visit 
Date : 2020-07-24 
Time: 09H00
Venue: Howick Forensic Mortuary





QUOTES CAN BE COLLECTED FROM: www.kznhealth.gov.za

QUOTES SHOULD BE DELIVERED TO: Hand delivered to 310 Jabu Ndlovu street, Old Boys Model, Quotation Box or email Quotations.scmho@kznhealth.gov.za

ENQUIRIES REGARDING THE ADVERT MAY BE DIRECTED TO:

Name: Nolwazi Mthembu
Email: nolwazi.mthembu1@kznhealth.gov.za
Contact Number: 033-8158411
Finance Manager Name: Mr T. Ashby
Finance Manager Signature: 

No late quotes will be considered

 Submit |  Save | Save As... |  Close |  Print Preview

[Print this page](#)

Note:

1. The completed Quotation Advert must be printed and signed by the Finance manager.
2. A signed copy of the Quotation Advert must be scanned and emailed to web administration: webmaster@kznhealth.gov.za for uploading to the department website.
3. N.B if the scanned copy emailed to web Administration is not a signed copy (by the finance manager), the advert/award WILL NOT be uploaded.

Site Updated:20 July, 2020, 03:24 pm

The materials on this website may be copied for non-commercial use as long as our copyright notice and website address are included.

Copyright © KwaZulu-Natal Department of Health, 2000

Contact the Web Administrator

ARE YOU THE ACCREDITED REPRESENTATIVE IN SOUTH AFRICA FOR THE GOODS / SERVICES / WORKS OFFERED? [IF YES ENCLOSE PROOF]

OFFICIAL PRICE PAGE FOR QUOTATIONS

SIGNATURE OF BIDDER DATE.....
 [By signing this document I hereby agree to all terms and conditions]

CAPACITY UNDER WHICH THIS QUOTE IS SIGNED.....

| Item No | Quantity | Description | Brand & model | Country of manufacture | Price | |
|---|----------|--|---------------|------------------------|-------|---|
| | | | | | R | c |
| 1 | 1 | Replacement of faulty body cabinets by walk in cold room at Howick Forensic Mortuary CIDB grading 2ME or above is compulsory | | | | |
| | | Compulsory Site Inspection Venue: Howick Forensic Mortuary Date: 24/07/2020 @ 09H00 | | | | |
| | | NB: Specification attached | | | | |
| | | Original documents required in a sealed envelope with current CSD summary report reflecting banking details, certified copy of B-BBEE certificate by verified agency and accredited by SANAS , Tax Clearance certificate or SARS pin | | | | |
| | | Responses to be hand delivered at 310 Jabu Ndlovu street, Old Boys Model Tender Quotation Box or emailed to Quotations.scmho@kznhealth.gov.za | | | | |
| VALUE ADDED TAX (Only if VAT Vendor) | | | | | | |
| TOTAL QUOTATION PRICE (VALIDITY PERIOD 60 Days) | | | | | | |

| | |
|--|--|
| Does This Offer Comply With The Specification? | Does The Article Conform To The S.A.N.S. / S.A.B.S. Specification? |
| Is The Price Firm? | State Delivery Period E.G. E.G. 1day, 1week |

| | |
|---|---|
| Enquiries regarding the <u>quote</u> may be directed to: Contact Person: <u>Nolwazi Mthembu</u> Tel: <u>033-815 8411</u> | Enquiries regarding <u>technical information</u> may be directed to: Contact Person: <u>Ernest Zulu</u> Tel <u>033-9402526</u> |
|---|---|



health

Department:
Health

PROVINCE OF KWAZULU-NATAL

INFRASTRUCTURE DEVELOPMENT

REPLACEMENT OF BODY CABINETS BY COLDROOM

AT

UMGUNGUNDLOVU HEALTH DISTRICT

(Howick Forensic Mortuary)

UMGUNGUNDLOVU FORENSIC MORTUARIES
HOWICK FORENSIC MORTUARY:
REPLACEMENT OF BODY CABINETS BY COLDROOM

1 CONDITIONS OF CONTRACT

1.1 NOTICE TO BIDDERS

- 1.1.1 The institutions will remain open and operational at all times therefore the Contractor shall make the necessary arrangements with the Institutional Management and maintenance staff for any power outages that are required. **This may necessitate weekend work**
- 1.1.2 All rubble shall to be removed from the institution's property immediately.
- 1.1.3 All equipment and materials used in this contract shall be that which is specified or **other approved prior to submission and closure of the bid.**
- 1.1.4 The Contractor is advised to examine all the drawings (if any) and to visit the site prior to tendering to acquaint him/herself with the nature of the work to be done and access to the siting of the existing buildings etc., as no claim will be allowed on the grounds of ignorance of the conditions under which the work will be executed.
- 1.1.5 All items quantities in the Schedule of Prices are **PROVISIONAL** and subject to re-measure after installation.
- 1.1.6 The Schedule of Prices shall be read in conjunction with the Scope of Work. Any discrepancies or omissions shall be brought to the attention of the Project Leader immediately.
- 1.1.7 **Preference will be given to Bidders who have registered offices / workshops within the borders of the Province of KwaZulu-Natal. This is in an effort to reduce response times to call outs for breakdowns in the more remote areas of the Province.**
- 1.1.8 The Contractor must be registered with CIDB and must have minimum grading of **2ME or above**
- 1.1.9 The Contractor must be registered with the relevant body i.e. **SARACCA or SAIRAC**
- 1.1.10 **The Contractor must be competent with proven experience in installation of cold – rooms and equipment with traceable references.**

1.2 EXECUTION PERIOD

One (1) month is the specified completion period for the construction stage from the date of the order issued

1.3 Required documentation to accompany you completed quotation form;

- 1.3.1** Proof of Refrigeration and Air Conditioner Trade test certificates.
- 1.3.2** Proof of relevant experience (Attach order number/Award letter/Completion certificate)
- 1.3.3** Registration with the relevant body (SAIRAC or SARACCA), attach a proof.
- 1.3.4** Proof of CIDB registration of 2ME or above must be attached.
- 1.3.5** Health and safety plan/policy relevant to this work.

UMGUNGUNDLOVU FORENSIC MORTUARIES
HOWICK FORENSIC MORTUARY:
REPLACEMENT OF BODY CABINETS BY COLDROOM

PART 2

TECHNICAL SPECIFICATION

2 **TECHNICAL SPECIFICATION**

2.1 **COMPLIANCE WITH REGULATIONS AND STANDARD SPECIFICATIONS**

These works are to be carried out in accordance with the KwaZulu-Natal Province Standard Specification for Refrigeration Services reference M-RCFM Issue 1 1998 and the KZN Standard specification for Air-conditioning and ventilation Services.

The operation, construction, material and components of the equipment, as specified, shall comply with the latest requirements of:

The Occupational Health and Safety Act (Act 85, 1993) as amended

The control panel, associated components and wiring shall be installed in compliance with the Department of Public Works and Land Affairs Standard Specification for the Electrical equipment and Installation for Mechanical Services Issue VIII September 1984.

SANS 10142: Code of Practice for Wiring of Premises

SANS 10147: Refrigeration systems including plants associated with air-conditioning systems

SANS 10400: The application of the National Building Regulations

SANS 14644: Clean rooms and associated controlled environments

An Electrical Certificate of Compliance, in accordance with the OHS Act as amended, will be required for all Electrical Works.

The Machinery and Occupational Safety Act - Act 6/1983

The Municipal By-laws and any special requirements of the Supply Authorities of the area or district concerned.

Local Fire Regulations.

All building works shall be in accordance with the Standard Preambles to All Trades.

The contractor should fully familiarise himself with these documents prior to quoting.

UMGUNGUNDLOVU FORENSIC MORTUARIES
HOWICK FORENSIC MORTUARY:
REPLACEMENT OF BODY CABINETS BY COLDROOM

PART 3

PARTICULAR SPECIFICATION

3.1. TECHNICAL SPECIFICATION

3.1.1 GENERAL

This Technical Specification shall be read in conjunction with all other sections of the Specification and cognisance shall be taken of the clauses relevant to this particular installation, whether any specific clauses are referred to or not.

3.1.2 GENERAL REQUIREMENTS

Tenderers are to make special note of the following:

This particular specification must be read with, and shall form part of, Part 4 of this document (Technical Specification).

In so far as the conditions contained herein are at variance with any obtained in the Technical Specifications, the contract shall be interpreted in terms of this Part 5 (Particular Specification).

The whole installation shall be in accordance with the Occupational Health and Safety Act 85/1993 and all regulations framed therein shall be carried out to the satisfaction of the Department of Health.

Competent workmen skilled in their trade shall carry out all work. Quality shall be of the best standard practice and all workmanship will be subject to the approval of the Department of Health.

The work shall at all times, for the duration of the contract, be carried out under the supervision of a skilled and competent representative of the Contractor, who will be able and authorized to receive and carry out instructions on behalf of the Contractor. A sufficient number of workmen shall be employed at all times to ensure satisfactory progress of the work.

All apparatus, component parts, fittings and materials employed in the execution of the Contract shall be new and unused and shall be the latest type or pattern of the particular manufacture employed. S.A.B.S. mark bearing items shall be used wherever possible.

The complete installation shall be maintained for a period of twelve months (12) after *the date of issue of the Completion Certificate* and shall allow for routine inspections.

The complete installation must be guaranteed against defective parts and workmanship for a period of twelve months (12) after the date of issue of the Completion Certificate. This period shall run concurrently with the maintenance period.

Rates are to include commissioning and testing of the complete installation and handing over in working order ready for use.

Tenderers are advised to visit the site and acquaint themselves fully with the site conditions and nature and full extent of work involved prior to submitting their tender. Claims on the grounds of insufficient information in such respects or otherwise will not be entertained by the Administration.

UMGUNGUNDLOVU FORENSIC MORTUARIES

HOWICK FORENSIC MORTUARY: REPLACEMENT OF BODY CABINETS BY COLDROOM

The Department of Health reserves the right to make emergency repairs to keep the equipment in operation without voiding the Contractor's Guarantee, nor relieving the Contractor of his responsibility during the guarantee period when, after proper notice, the Contractor fails to attend to such emergency repairs. All costs incurred by the Administration under these circumstances will be for the account of the Contractor.

NOTE: All electrical equipment shall comply with NER Regulation of voltage.

3.2 SCOPE OF CONTRACT

The specification calls for the replacement of mortuary body cabinets by cold-room and details are as follows:

- a) *Supply, deliver, install and commission cold-room and accessories 3000mm (L) x1650mm (W) x 1900mm (H)*
- b) *Multiple racking systems with body trays to accommodate a capacity of 12 bodies.*

The cold-room must be constructed of 100mm 16DV Polystyrene encased in 0.6mm white Chromadek steel sheeting. The floor must be insulated with 115mm 40kg/m³ Polyurethane slabs and covered with concrete that is finished with an epoxy coating. The cold-room will be serviced by two (2) compressors (Packaged units), main unit and backup unit with one evaporator coil inside the cold-room.

The load capacity of the compressors is such that there is a 100% stand by capacity on the refrigeration equipment. The compressors are run on a flip flop time cycle. This ensures that wear and tear on the equipment is equally spread through both units. The cold-room is set to run at a temperature of 3°C with a permissible variance of plus minus 3°C.

The cold-room must be fitted with two (1200mm) double tube fluorescent lights with the diffuser that are vapor sealed to ensure that there is no moisture penetration in the electrical fittings

Certificate of Conformity

The contractor shall supply the mandatory Certificate of Conformity as contemplated by the South African Refrigeration and Air-Conditioning Contractors Association showing the commissioning of the works and the SAQCC registration of the artisan working on the system. Practical completion of the works will not be taken without the signed certificate.

3.3 INSTALLATION DETAILS

All units are to use ozone-friendly refrigerants as per regulations.

The outside casing of the machine, its bolting equipment shall be protected against corrosion, water and dust ingress to a minimum rating of IP66. The quote shall contain a detailed corrosion protection plan by the contractor.

3.4 THE SITE

The site is **Howick** forensic Mortuary.

3.5 PROGRAM OF WORKS

It is imperative that the installation be achieved with minimum interruption to the existing facility. The contractor shall notify the institution seven (7) days prior to carrying out any site work. As the institution is to remain in full operation for the duration of the works, the works are to be planned and executed so as to cause minimum inconvenience to staff and visitors.

A program **WILL BE** submitted prior to the commencement of any work for the approval by the Project Leader. No work will commence without the program of works having been approved by the Project Leader.

UMGUNGUNDLOVU FORENSIC MORTUARIES

HOWICK FORENSIC MORTUARY: REPLACEMENT OF BODY CABINETS BY COLDROOM

3.6 ELECTRICAL

Satisfactory Installation:

- i) The Code of Practice for the Wiring of Premises as issued by the South African Bureau of standards (SANS 10142-1).
- ii) The KwaZulu-Natal Department of Health General Electrical Policy.
- iii) The Machinery and Occupational Safety Act - Act 6/1983.
- iv) The Municipal By-laws and any special requirements of the Supply Authorities of the area or district concerned.
- v) Local Fire Regulations.

Certificate of Compliance

The contractor shall submit the mandatory Certificate of Compliance. First delivery of this contract will not be taken until such time as this certificate is submitted to the Department of Health. All electrical work carried out will be neat and best class materials must be used. All wiring to conform to the S.A.B.S Code of Practice 10142 and will be subject to prior inspection and approval before acceptance. Refer to the Standard Electrical Specification; in as far as it applies.

3.7 TESTING AND COMMISSIONING

All new equipment shall be tested, commissioned, ready for use and be maintained and guaranteed for a period of twelve (12) months. Commissioning data is to be supplied before First Delivery of this contract is taken. All equipment to be supplied with nameplates showing the Technical Information as well as all the information as contemplated by the Occupational Health and Safety Act, 85 of 1993, as amended and its regulations, showing particularly the following information

- i) Name of manufacturer
- ii) Country of origin
- iii) Year of manufacture
- iv) Manufacturer's name, serial number and model number

3.8 MAINTENANCE MANUALS

One (1) set of maintenance and operating manuals are required which shall include all circuit diagrams, spare parts lists, operating instructions, etc. These sets of drawings shall be provided at the practical completion date and the Practical Completion Certificate will NOT be issued without these documents.

3.9 MAINTENANCE AND SERVICING

The entire installation including all new equipment manufactured or bought is subject to an unrestricted 12-month free maintenance and guarantee period, after the date of issue of the Completion Certificate. This also includes cover pertaining to all aspects of the equipment and associated wiring, piping, controls etc.

During the 12-month maintenance and servicing period any defects shall be made good and all plant and equipment maintained in perfect operating condition. The services will be carried as follows:

- 3 x minor services. First minor service to be done three (3) months from the date of Practical Completion Certificate. Thereafter, the services will be done on a 3-month basis
- 1 x major service to be done before Final Completion Certificate. This date shall be twelve (12) months from the date of Practical Completion Certificate.

UMGUNGUNDLOVU FORENSIC MORTUARIES
HOWICK FORENSIC MORTUARY:
REPLACEMENT OF BODY CABINETS BY COLDROOM

PART 4

SCHEDULE OF PRICES

PREAMBLE TO THE SCHEDULE OF PRICES

1. All prices shall be quoted in the currency of the Republic of South Africa and will be fixed. Only where exchange rates have been stated in the quotation document, as at two weeks (14 days) prior to closing date of this quotation, will such exchange rate fluctuation be taken into account in the variation of the cost of the imported items/equipment.
2. The Tenderer shall enter a price against each item in the schedule of prices. If the Tenderer fails to enter a price against any item in the schedule of prices the relevant cost of such item shall be regarded as being covered by other prices in the schedule of prices.
3. **The prices quoted against each item of these schedules shall cover the full inclusive cost of everything required for the execution of the work under the item plus an apportionment of any cost involved in meeting the obligations and liabilities imposed by the conditions of contract and in complying with the specifications.**
4. The prices quoted for the supply of plant and equipment shall include for all handling, loading, transporting and off-loading required for the delivery of the plant and equipment to the site, including in the case of off-site storage for double handling at the store.
5. The prices quoted for erection and installation shall include for all handling, loading, transporting and off-loading, to take plant and equipment to place on site where required, erection, installation, painting, commissioning, operating, testing, adjusting, handing over in proper working order and guarantee for a period of 12 months, all as specified.
6. The tendered rates and amounts must exclude Value Added Tax (VAT) but must include all levies, other taxes and duties on items to which they apply. Separate provision has been made in the Summary of Schedule of Prices for the purpose of VAT.
7. Amounts allowed for contingencies will be spent in part or as a whole at the sole discretion of the Department of Health's "Representative".
8. The Schedule of Prices shall be completed and signed in **black ink**. Corrections must be done by deleting, re-writing and initialling next to the amendment.
9. Electrical and Mechanical work is not measured according to the Standard Procedures of Building Work.

UMGUNGUNDLOVU FORENSIC MORTUARIES

HOWICK FORENSIC MORTUARY:
REPLACEMENT OF BODY CABINETS BY COLDROOM

4.1 SCHEDULE OF PRICES: MATERIALS, COMPONENT/ANCILLARY PARTS AND SUB CONTRACT WORK

The service provider shall add here, ALL materials, components/ancillary parts and labour which are required for the completion of the work quoted for.

This must be read in conjunction with the scope of works as indicated on item 3.2 in this document.

| ITEM | DESCRIPTION | MANUFACTURER | QTY | UNIT COST | TOTAL COST (EXCLUDING VAT) |
|------------------------------|--|--------------|-----|-----------|----------------------------|
| 4.1.1 | Supply, deliver, install and commission cold-room and accessories 3000mm (L) x1650mm (W) x 1900mm (H) | | 1 | | |
| 4.1.2 | Multiple racking systems with body trays to accommodate a capacity of 12 bodies. | | 1 | | |
| 4.1.3 | Condensing unit (Packaged) and accessories | | 2 | | |
| 4.1.4 | Evaporator coil and accessories | | 1 | | |
| 4.1.5 | Supply, deliver, install and commission two (2 x 1200mm), double fluorescent lights with diffuser that are vapor sealed to prevent moisture penetration. | | 2 | | |
| 4.1.6 | Carry out three (3) minor services | | 3 | | |
| 4.1.7 | Carry out one (1) major service | | 1 | | |
| 4.1.8 | Provide Certificate of Compliance (COC) | | 1 | | |
| 4.1.9 | Provide Certificate of Conformity | | 1 | Free | Free |
| 4.1.10 | Other | | 1 | | |
| TOTAL (EXCLUDING VAT) | | | | | |

1. TENDER EVALUATION CRITERIA AND SCORING

The Bidders needs to score a minimum of 65 points functionality and quality criteria to be considered for this quotation:

| Evaluation Criteria | Deliverables | Points | Sub-Points | Sub-Criteria | Sub-Points Scoring |
|--|---|-----------|---------------|---|---|
| Financial Standing | The submission of all financial requirements stipulated in the tender | 30 Points | 15 Sub-points | Stamped letter from the bank confirming availability of working capital | 15 Proof of working capital equal to or greater than R100 000.00 in the form of a stamped letter from the bank. |
| | | | | | 5 Proof of working capital from R50 000- R99 999.00 in the form of a stamped letter from the bank. |
| | | | | | 0 Proof of working capital from R0 –R49 999 or no submission. |
| Competency, Experience and Resource Capacity | Tenderer to demonstrate their technical competency, human resource capacity and relevant project experience | 30 Points | 15 Sub-points | Stamped proof of available credit limit from the bank. | 15 Proof of available credit limit equal to or greater than R100 000.00 in the form of a stamped letter from the registered and approved financial services providers. |
| | | | | | 5 Proof of available credit limit from R50 000- R99 999.00 in the form of a stamped letter from the registered and approved financial services providers. |
| | | | | | 0 Proofs of credit limit from R0 –R49 999 or no submission. |
| Competency, Experience and Resource Capacity | Tenderer to demonstrate their technical competency, human resource capacity and relevant project experience | 30 Points | 20 Sub-points | Detailed schedule of resources at all levels. Please note that per key technical role; only one resource per role will be scored. | 20 100% of Key technical resources on the project organogram have a minimum of 3 years' experience on similar project. Key technical Resources: Technical Manager, Foreman or Supervisor with proof of trade test certificate (Refrigeration and Air Conditioner Trade test), Technical Assistants (semi-skilled) with the proof of similar project experience |
| | | | | | 10 50 - 99% of Key Technical resources on the project organogram have a minimum of 3 years' experience on similar project. Key technical Resources: Technical Manager, Foreman or Supervisor, with proof of trade test certificate (Refrigeration and Air Conditioner Trade test), Technical Assistants (semi-skilled) with the proof of similar project experience. |

| Evaluation Criteria | Deliverables | Points | Sub-Points | Sub-Criteria | Sub-Points Scoring |
|---|---|-----------|------------|--|--|
| | | | | | <p>0 - 50% of Key Technical resources on the project organogram has a minimum of 3 years' experience on similar project. Key technical Resources: Technical Manager, Foreman or Supervisor with proof of trade test certificate (Refrigeration and Air Conditioner Trade test), Technical Assistants (semi-skilled) with the proof of similar project experience</p> |
| Tenderer's Project Management Structure, Experience of Resources Proposed for the Project and CIDB requirements. | A tenderer that submits a detailed project organogram that sets out the roles and responsibilities of each proposed team member, which is backed up by their curriculum vitae that demonstrate extensive experience, together with a project implementation structure shall be allocated maximum sub-points. In all other instances zero (0) sub-points shall be allocated. | 15 | 10 | Schedule of organisation years of experience on similar projects (Project includes servicing of plumbing and related accessories. Bidder must submit a schedule of projects completed which shall include period (start date/month to end date/month) over which completed and value of project. | <p>0</p> <p>10 More than or equal to 3 years with award letters/orders/completion certificates not older than 10 years.</p> <p>5 Greater than or equal to 1 year but less than 3 years with award letters/orders/completion certificates.</p> <p>0 Less than 1 year.</p> |
| | | 15 Points | 15 | Submission of a detailed organogram and CIDB requirements | <p>15</p> <ul style="list-style-type: none"> Submission of a detailed project organogram showing all project resources including key technical resources. The organogram must indicate the roles and responsibilities of each key project team members that will be allocated to this project. CIDB required for this job is 2ME and proof must be attached |
| | | | | | <p>5</p> <ul style="list-style-type: none"> Submission of a detailed project organogram showing all project resources including key technical resources. The organogram must indicate the roles and responsibilities of each key project team members that will be allocated to this project. OR CIDB required for this job is 2ME and proof must be attached |
| | | | | | <p>0</p> <p>No Submission</p> |
| Locality | Submission of proof of location (Physical Address of the tenderer's premises) and the distance away from site (or various sites in the event of various facilities) | 10 | 10 | Submission of proof of location (Physical Address of the tenderer's premises) and the distance away from the furthest site (or various sites in the event of various facilities) | <p>10</p> <p>Distance away from Howick MLM is less than 100km.</p> |
| | | | | | <p>5</p> <p>Distance away from Howick MLM is between 101km and 200km.</p> |
| | | | | | <p>0</p> <p>No submission or distance greater than 200km.</p> |

| Evaluation Criteria | Deliverables | Points | Sub-Points | Sub-Criteria | Sub-Points Scoring |
|---------------------|--|----------------------|--------------------------|---|--|
| Safety | <p>Submission of the tenderer's Safety Policy or equivalent, demonstrating 1. Safe working procedures/ processes, 2. controls and guidelines that will give confidence to the Department that safety will be prioritised, 3. risk assessments, 4. tools and site inspections will be conducted, 5. First Aid kit will be provided, 6. Safety Officer will be made available (or at least a foreman will act as a Safety custodian). 7. Incidents will be reported and investigated as per OHS Act and Regulations.</p> | <p>15 Points</p> | <p>15 Sub-points</p> | <p>Submission of the tenderer's Safety Policy of equivalent, demonstrating safe working procedures, processes, controls and guidelines that will give confidence to the Department that safety will be prioritised, risk assessments, tools and site inspections will be conducted. First Aid kit will be provided, Safety Officer will be made available (or at least a foreman will act as a Safety custodian). Incidents will be reported and investigated as per Osh Act and Regulations.</p> | <p>15 Submission of the tenderer's Safety Policy or equivalent, demonstrating full coverage of all 7 (or more) safety aspects as per the list on the deliverables.</p> |
| | | | | | <p>5 Submission of the tenderer's Safety Policy or equivalent, demonstrating coverage of 5 safety aspects as per the list on the deliverables.</p> |
| | | | | | <p>0 No submission covering safety aspects as per the list on the deliverables.</p> |

KWAZULU NATAL

DEPARTMENT OF HEALTH

Project

MORTUARY COLD ROOM

BODY STORAGE SYSTEM

STAINLESS STEEL
RACKING DETAIL

FRONT ELEVATION

Drawn By:-

A.E.Stanley
P.Bag x 9051
Pietermaritzburg
3200
Tel 083 4571240

Scale 1:

Date

9/10/2007

Signature

Drawing No.

SSR 1 - 8 R

This drawing and design is
copyright and must not be
reproduced in part or in whole
without prior written consent.
Contractors must verify all
dimensions on site before
commencing work or preparing
shop drawings.

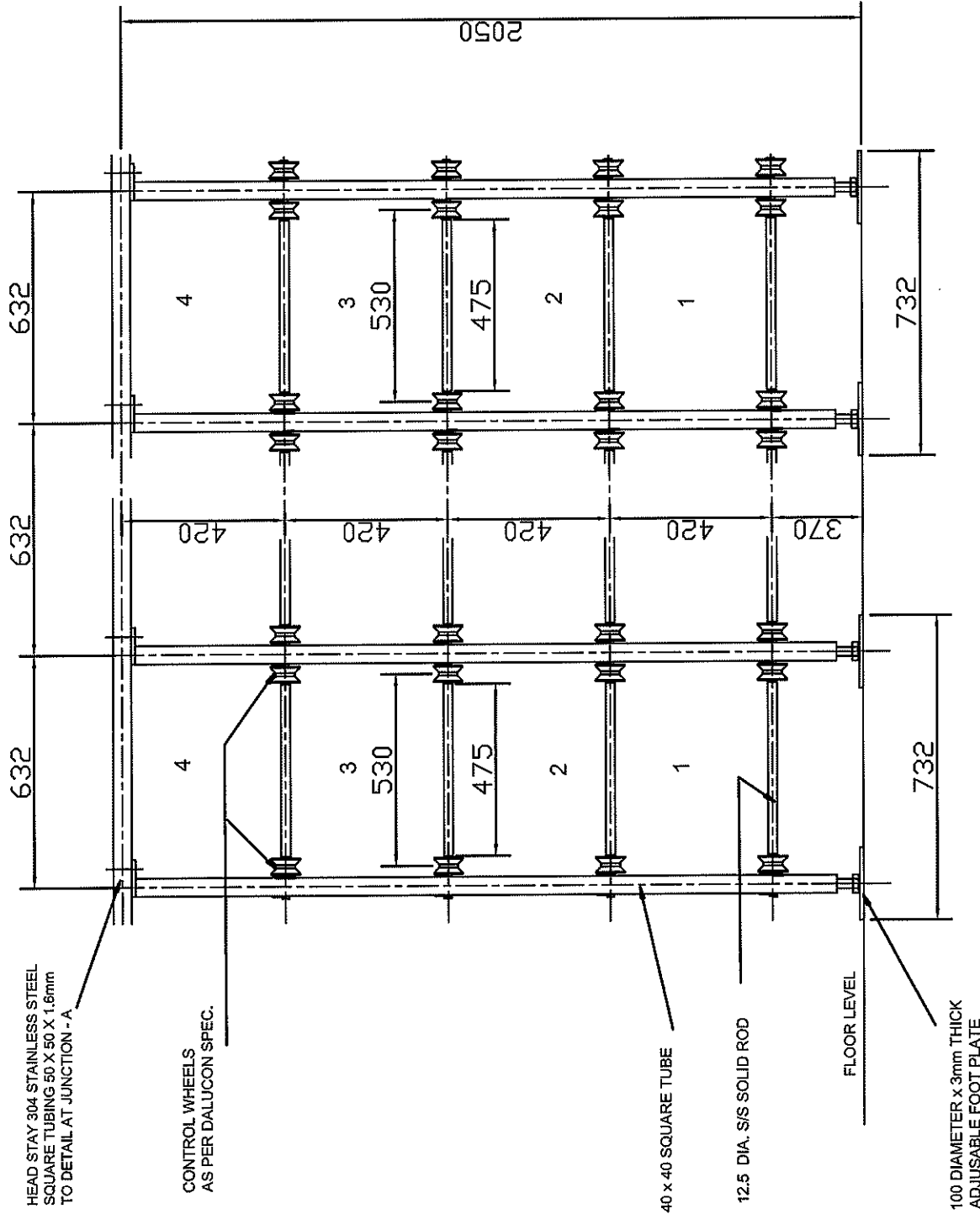

FRONT ELEVATION

KWAZULU NATAL

DEPARTMENT OF HEALTH

Project

MORTUARY COLD ROOM
BODY STORAGE SYSTEM

STAINLESS STEEL
RACKING DETAIL

REAR ELEVATION

Drawn By:-

A.E. Stanley
P. Bag x 9051
Pietermaritzburg
3200
Tel 083 4571240

Scale 1: Date

11/10/2007

Signature

Drawing No.

SSR 2 - 8 R

This drawing and design is
copyright and must not be
reproduced in part or in whole
without prior written consent.
Contractors must verify all
dimensions on site before
commencing work or preparing
shop drawings.

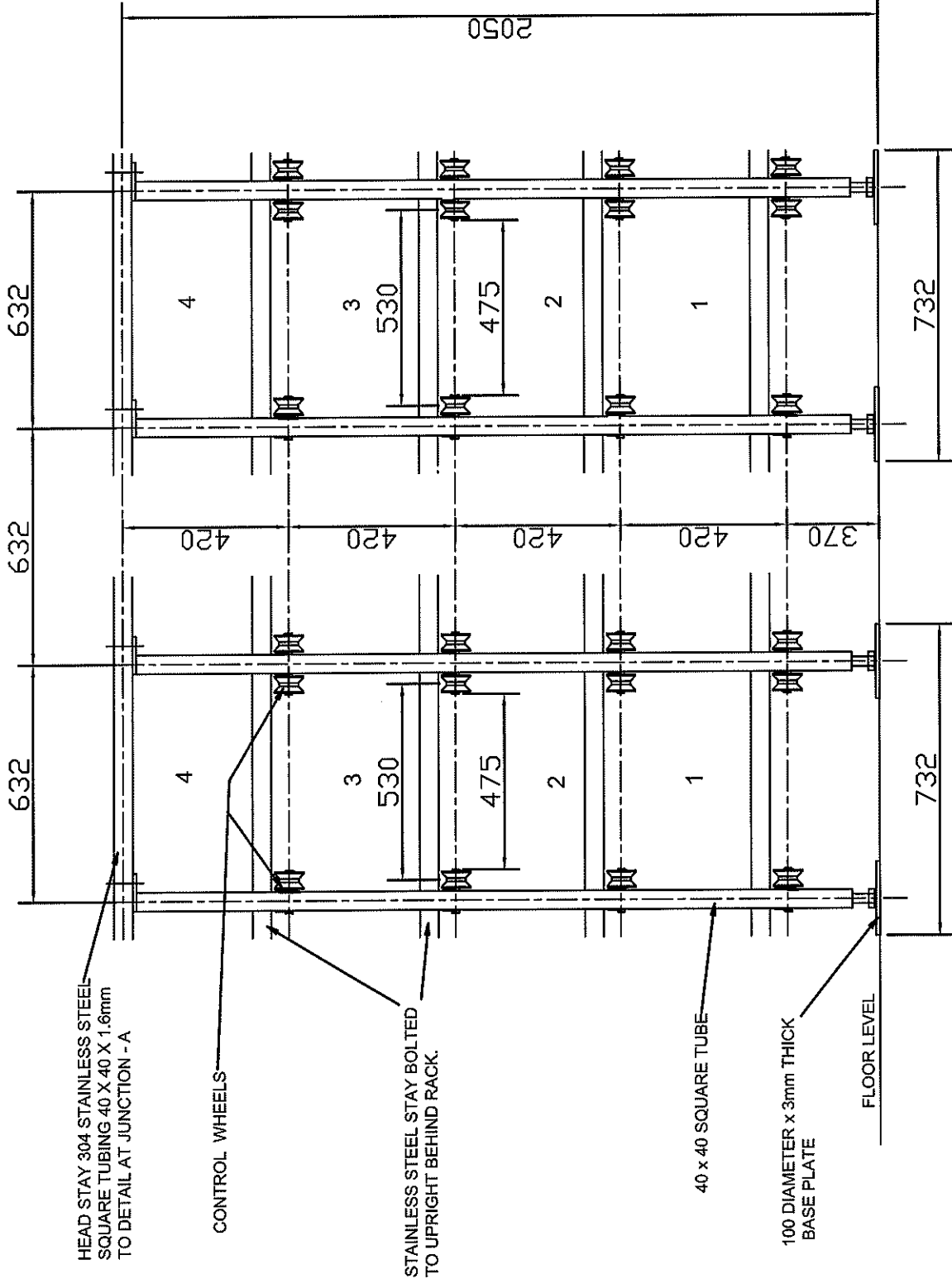

REAR ELEVATION
SECTIONAL VIEW

KWAZULU NATAL

DEPARTMENT OF HEALTH

Project

MORTUARY COLD ROOM
BODY STORAGE SYSTEM

STAINLESS STEEL
RACKING DETAIL

SIDE ELEVATION

Drawn By:-

A.E.Stanley
P.Bag x 9051
Pietermaritzburg
3200
Tel 083 4571240

Scale 1: Date 11/10/2007

Signature

Drawing No. SSR 4 - 8 R

This drawing and design is
copyright and must not be
reproduced in part or in whole
without prior written consent.
Contractors must verify all
dimensions on site before
commencing work or preparing
shop drawings.

- 1 HEAD STAY : STAINLESS STEEL
TUBE 40mm x 40mm x 1.6mm
 - 2 MAIN SHAFT ROLLER ASSEMBLY
 - 3 SINGLE ROLLER SHAFT ASSEMBLY
 - 4 DOUBLE ROLLER SHAFT ASSEMBLY
 - 5 MAIN BEARER FOR ROLLERS
304 STAINLESS STEEL SQUARE
TUBING 40mm x 40mm x 1.6mm
 - 6 STRUT : 304 STAINLESS STEEL
SQUARE TUBING 40mm x 40mm x 1.6mm
 - 7 FRONT BEARER MOUNTING PLATE
304 S/S x 3mm THICKNESS
 - 8 REAR BEARER MOUNTING PLATE
304 S/S 3mm THICKNESS
 - 9 ROLLER SUPPORT 304 S/S 3mm TH.
 - 10 NYLON ROLLER
 - 11 CIR CLIP S/S 15mm INT. DIA. x 2mm
THICKNESS
- SPECIAL NOTES :
- ALL BOLTS, SCREWS, WASHERS,
AND NUTS SHALL BE OF CORROSIVE
RESISTANT MATERIAL.
 - FRONT BEARER MOUNTING PLATE,
REAR BEARER MOUNTING PLATE
AND ROLLER SUPPORT SHALL BE
WELDED ON TO THE MAIN BEARER
AS INDICATED ON DRAWING.
 - ALL SHARP EDGES SHALL BE
MADE SMOOTH.
 - ALL CHAMFERS SHALL BE 45 DEGREE
x 2mm UNLESS OTHERWISE STATED.

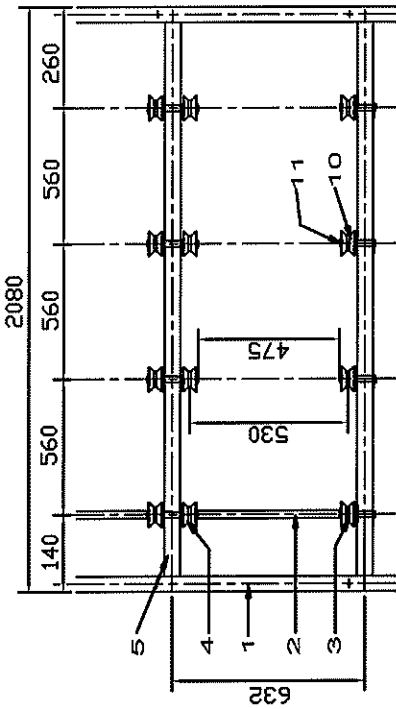

TOP ELEVATION

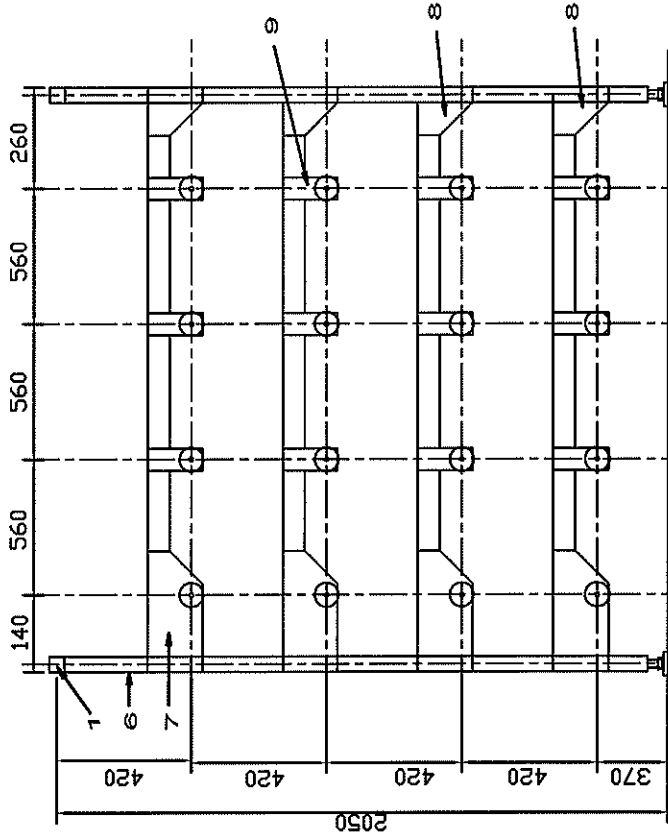

SIDE ELEVATION



KWAZULU NATAL
DEPARTMENT OF HEALTH

Project

**MORTUARY COLD ROOM
BODY STORAGE SYSTEM**

**STAINLESS STEEL
RACKING DETAIL**

**REAR ELEVATION
STOPPER DETAIL**

Drawn By:-

A.E.Stanley
P.Bag x 9051
Pietermaritzburg
3200
Tel 083 4571240

Scale 1: Date

22/10/2007

Signature

Drawing No. **SSR 5 - 8 R**

This drawing and design is copyright and must not be reproduced in part or in whole without prior written consent. Contractors must verify all dimensions on site before commencing work or preparing shop drawings.

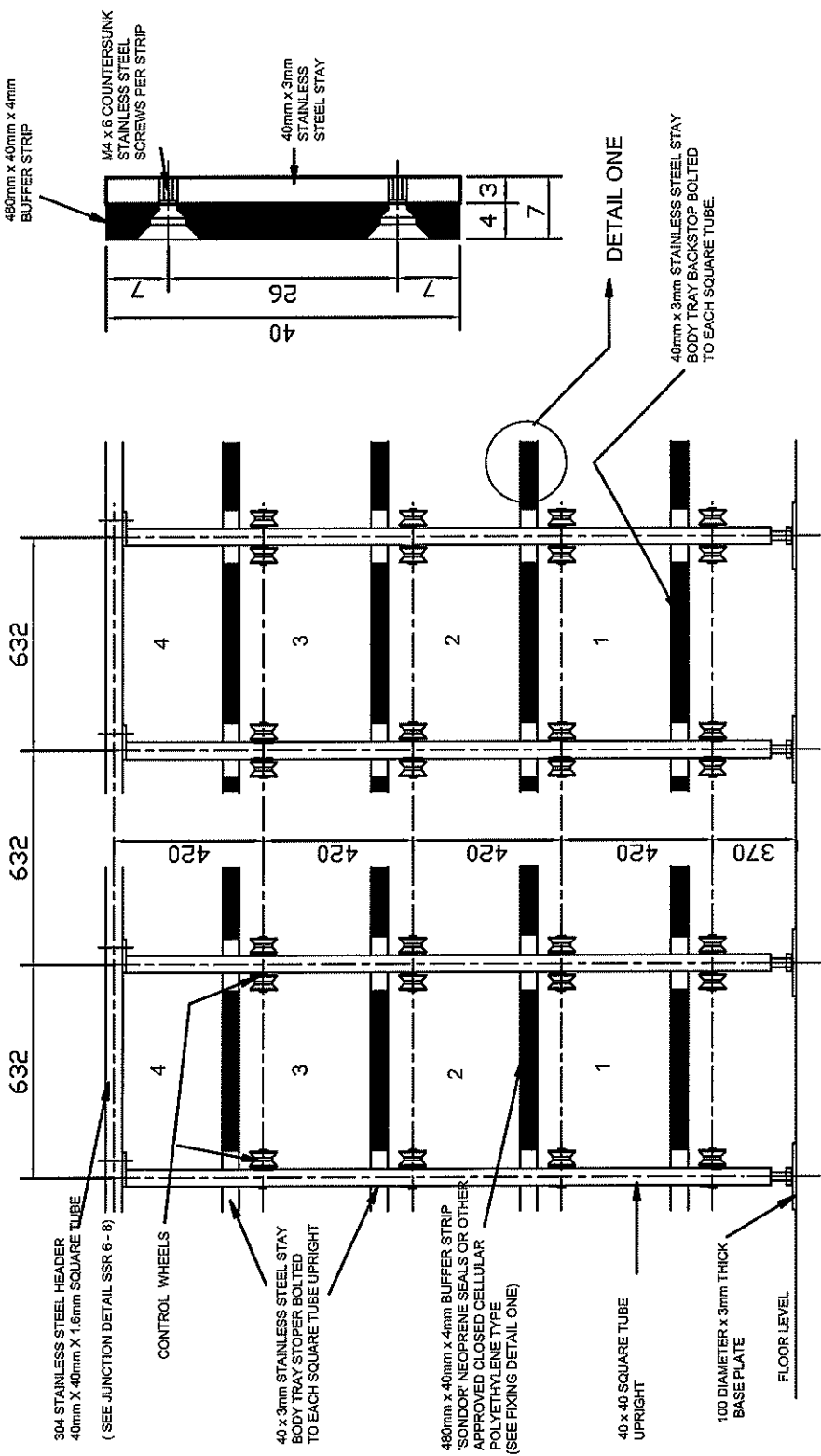

**SECTIONAL REAR ELEVATION
SHOWING BUFFERS IN POSITION**

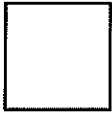

KWAZULU NATAL
DEPARTMENT OF HEALTH

Project

MORTUARY COLD ROOM
BODY STORAGE SYSTEM.

STAINLESS STEEL
RACKING DETAIL

HEADER, UPRIGHT
AND BASE DETAIL

Drawn By:-

A.E. Stanley
P. Bag x 9051
Pietermaritzburg
3200
Tel 083 4571240

Scale 1: Date

22/10/2007

Signature

Drawing No. **SSR 6 - 8 R**

This drawing and design is copyright and must not be reproduced in part or in whole without prior written consent. Contractors must verify all dimensions on site before commencing work or preparing shop drawings.

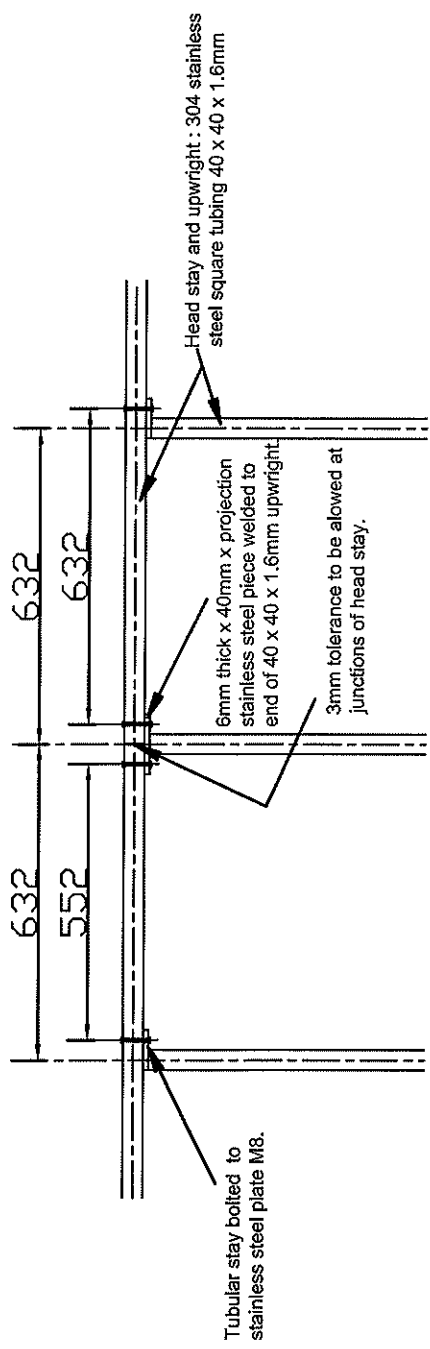

DETAIL-A HEAD STAY
AT STRUT JUNCTION

THIS DRAWING TO BE READ IN CONJUNCTION
WITH DRWG. NO. SSR 1 - 8

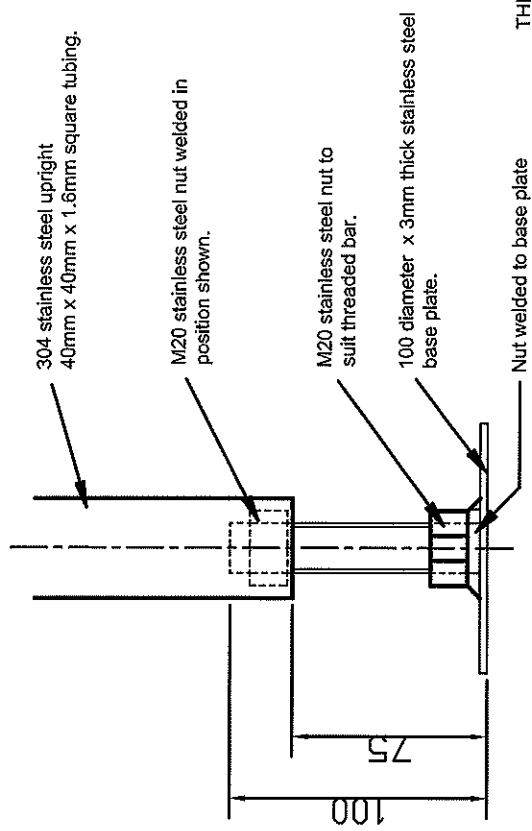

DETAIL - B

ADJUSTABLE FOOT AT BASE OF RACK UPRIGHT

THIS DRAWING TO BE READ IN CONJUNCTION
WITH DRAWING NUMBER SSR 3 - 8

DECLARATION OF INTEREST

1. Any legal person, including persons employed by the state¹, or persons having a kinship with persons employed by the state, including a blood relationship, may make an offer or offers in terms of this invitation to quote (includes a price quotation, advertised competitive quote, limited quote or proposal). In view of possible allegations of favouritism, should the resulting quote, or part thereof, be awarded to persons employed by the state, or to persons connected with or related to them, it is required that the bidder or his/her authorised representative declare his/her position in relation to the evaluating/adjudicating authority where-
 - the bidder is employed by the state; and/or
 - the legal person on whose behalf the bidding document is signed, has a relationship with persons/a person who are/is involved in the evaluation and or adjudication of the quote(s), or where it is known that such a relationship exists between the person or persons for or on whose behalf the declarant acts and persons who are involved with the evaluation and or adjudication of the quote.
2. In order to give effect to the above, the following questionnaire must be completed and submitted with the quote.

- | | |
|---|---|
| 2.1. Full Name of bidder/representative..... | 2.4. Company Registration Number: |
| 2.2. Identity Number: | 2.5. Tax Reference Number: |
| 2.3. Position occupied in the Company (director, trustee, shareholder?):..... | 2.6. VAT Registration Number: |

2.7. The names of all directors / trustees / shareholders / members, their individual identity numbers, tax reference numbers and, if applicable, employee / persal numbers must be indicated in paragraph 3 below. [TICK APPLICABLE]

2.8. Are you or any person connected with the bidder presently employed by the state? YES NO

2.8.1. If so, furnish the following particulars:
 Name of person / director / trustee / shareholder/ member:
 Name of state institution at which you or the person connected to the bidder is employed:.....
 Position occupied in the state institution: Any other particulars:.....

2.8.2. If you are presently employed by the state, did you obtain the appropriate authority to undertake remunerative work outside employment in the public sector? YES NO

2.8.2.1. If yes, did you attach proof of such authority to the quote document?

(Note: Failure to submit proof of such authority, where applicable, may result in the disqualification of the quote.)

2.8.2.2. If no, furnish reasons for non-submission of such proof:

2.9. Did you or your spouse, or any of the company's directors / trustees / shareholders / members or their spouses conduct business with the state in the previous twelve months? YES NO

2.9.1. If so, furnish particulars:.....

2.10. Do you, or any person connected with the bidder, have any relationship (family, friend, other) with a person employed by the state and who may be involved with the evaluation and or adjudication of this quote? YES NO

2.10.1. If so, furnish particulars:.....

2.11. Are you, or any person connected with the bidder, aware of any relationship (family, friend, other) between any other bidder and any person employed by the state who may be involved with the evaluation and or adjudication of this quote? YES NO

2.11.1. If so, furnish particulars:.....

2.12. Do you or any of the directors / trustees / shareholders / members of the company have any interest in any other related companies whether or not they are bidding for this contract? YES NO

2.12.1. If so, furnish particulars:.....

3. Full details of directors / trustees / members / shareholders.

NB: The Department Of Health will validate details of directors / trustees / members / shareholders on CSD. It is the suppliers' responsibility to ensure that their details are up-to-date and verified on CSD. If the Department cannot validate the information on CSD, the quote will not be considered and passed over as non-compliant according to National Treasury Instruction Note 4 (a) 2016/17.

4 DECLARATION

I, THE UNDERSIGNED (NAME).....CERTIFY THAT THE INFORMATION FURNISHED IN PARAGRAPHS 2.

I ACCEPT THAT THE STATE MAY REJECT THE QUOTE OR ACT AGAINST ME SHOULD THIS DECLARATION PROVE TO BE FALSE.

| | | | |
|----------------|-----------|----------|-------|
| | | | |
| Name of bidder | Signature | Position | Date |

"State" means –

- | | |
|---|---|
| a) any national or provincial department, national or provincial public entity or constitutional institution within the meaning of the Public Finance Management Act, 1999 (Act No. 1 of 1999); | c) provincial legislature; |
| b) any municipality or municipal entity; | d) national Assembly or the national Council of provinces; or |
| | e) Parliament. |

"Shareholder" means a person who owns shares in the company and is actively involved in the management of the enterprise or business and exercises control over the enterprise.

SPECIAL CONTRACT CONDITIONS OF QUOTATIONS

1. AMENDMENT OF CONTRACT

1.1. Any amendment to or renunciation of the provisions of the contract shall at all times be done in writing and shall be signed by both parties.

2. CHANGE OF ADDRESS

2.1. Bidders must advise the Department of Health (institution where the offer was submitted) should their address (*domicilium citandi et executandi*) details change from the time of bidding to the expiry of the contract.

3. GENERAL CONDITIONS ATTACHED TO THIS QUOTATION

- 3.1. The institution is under no obligation to accept the lowest or any quote.
- 3.2. The price quoted must include VAT (if VAT vendor). However, it must be noted that the department reserves the right to evaluate all quotations excluding VAT as some bidders may not be VAT vendors.
- 3.3. The bidder must ensure the correctness & validity of quote:
 - (i) that the price(s), rate(s) & preference quoted cover all for the work/item (s) & accept that any mistakes regarding the price (s) & calculations will be at the bidder's risk
- 3.4. The bidder must accept full responsibility for the proper execution & fulfilment of all obligations conditions devolving on under this agreement, as the Principal (s) liable for the due fulfilment of this contract.
- 3.5. This quotation will be evaluated based on the 80/20 points system, specification & correctness of information. All required documentation must be completed in full and submitted.
- 3.6. Offers must comply strictly with the specification.
- 3.7. Only offers that meet or are greater than the specification will be considered.
- 3.8. Late quotes will not be considered.
- 3.9. Expired product/s will not be accepted. All products supplied must be valid for a minimum period of six months.
- 3.10. A bidder not registered on the Central Suppliers Database or verification has failed will not be considered.
- 3.11. All delivery costs must be included in the quote price, for delivery at the prescribed destination.
- 3.12. Only firm prices will be accepted. Such prices must remain firm for the contract period. Non-firm prices (including rates of exchange variations) will not be considered.
- 3.13. In cases where different delivery points influence the pricing, a separate pricing schedule must be submitted for each delivery point.
- 3.14. In the event of a bidder having multiple quotes, only the cheapest according to specification will be considered. Furthermore a verification will be done to identify if bidders have multiple companies and are quoting (cover-quoting) for this bid. In such instances only the cheapest bid according to specification will be considered.

4. SAMPLES

- 4.1. In the case of the quote document stipulating that samples are required, the supplier will be informed in due course when samples should be provided to the institution. (This decreases the time of safety and storage risk that may be incurred by the respective institution). The bidders sample will be retained if such bidder wins the contract.
 - (i) If a company/s who has not won the quote requires their samples, they must advise the institution in writing of such.
 - (ii) If samples are not collected within three months of close of quote the institution reserves the right to dispose of them at their discretion.
- 4.2. **Samples must be made available when requested in writing or if stipulated on the document.**
 - (i) If a Bidder fails to provide a sample of their product on offer for scrutiny against the set specification when requested, their offer will be rejected. All testing will be for the account of the bidder.

5. COMPULSORY SITE INSPECTION / BRIEFING SESSION

5.1. Bidders who fail to attend the compulsory meeting will be disqualified from the evaluation process.

- (i) The institution has determined that a compulsory site meeting take place
- (ii) Date 24 /07 /2020 Time 09 :00 Place Howick Forensic Mortuary

| | |
|--------------------|--|
| Institution Stamp: | Institution Site Inspection / briefing session Official Full Name: Signature: Date: |
|--------------------|--|

6. STATEMENT OF SUPPLIES AND SERVICES

- 6.1. The contractor shall, when requested to do so, furnish particulars of supplies delivered or services executed. If he/she fails to do so, the Department may, without prejudice to any other rights which it may have, institute inquiries at the expense of the contractor to obtain the required particulars.

7. SUBMISSION AND COMPLETION OF SBD 6.1

- 7.1. Should a bidder wish to qualify for preference points they must complete a SBD 6.1 document. Failure by a bidder to provide all relevant information required, will result in such a bidder not being considered for preference point's allocation. The preferences applicable on the closing date will be utilized. Any changes after the closing date will not be considered for that particular quote.

8. TAX COMPLIANCE REQUIREMENTS

- 8.1. In the event that the tax compliance status has failed on CSD, ***it is the suppliers' responsibility to provide a SARS pin in order for the institution to validate the tax compliance status of the supplier.***
- 8.2. In the event that the institution cannot validate the suppliers' tax clearance on SARS as well as the Central Suppliers Database, ***the quote will not be considered and passed over as non-compliant according to National Treasury Instruction Note 4 (a) 2016/17.***

9. TAX INVOICE

- 9.1. A tax invoice shall be in the currency of the Republic of South Africa and shall contain the following particulars:

- (i) the name, address and registration number of the supplier;
- (ii) the name and address of the recipient;
- (iii) an individual serialized number and the date upon which the tax invoice is issued;
- (iv) a description and quantity or volume of the goods or services supplied;
- (v) the official department order number issued to the supplier;
- (vi) the value of the supply, the amount of tax charged;
- (vii) the words tax invoice in a prominent place.

10. PATENT RIGHTS

- 10.1. The supplier shall indemnify the **KZN Department of Health** (hereafter known as the purchaser) against all third-party claims of infringement of patent, trademark, or industrial design rights arising from use of the goods or any part thereof by the purchaser.

11. PENALTIES

- 11.1. if the supplier fails to deliver any or all of the goods or to perform the services within the period(s) specified in the contract, the purchaser shall, without prejudice to its other remedies under the contract, deduct from the contract price, as a penalty, a sum calculated on the delivered price of the delayed goods or unperformed services using the current prime interest rate calculated for each day of the delay until actual delivery or performance. The purchaser may also consider termination of the contract.

12. TERMINATION FOR DEFAULT

- 12.1. The purchaser, without prejudice to any other remedy for breach of contract, by written notice of default sent to the supplier, may terminate this contract in whole or in part:
- (i) if the supplier fails to deliver any or all of the goods within the period(s) specified in the contract,
 - (ii) if the supplier fails to perform any other obligation(s) under the contract; or
 - (iii) if the supplier, in the judgment of the purchaser, has engaged in corrupt or fraudulent practices in competing for or in executing the contract.
- 12.2. In the event the purchaser terminates the contract in whole or in part, the purchaser may procure, upon such terms and in such manner as it deems appropriate, goods, works or services similar to those undelivered, and the supplier shall be liable to the purchaser for any excess costs for such similar goods, works or services.
- 12.3. Where the purchaser terminates the contract in whole or in part, the purchaser may decide to impose a restriction penalty on the supplier by prohibiting such supplier from doing business with the public sector for a period not exceeding 10 years.

FAILURE TO COMPLY WITH ABOVE WILL RESULT IN YOUR QUOTE BEING PASSED OVER.

PREFERENCE POINTS CLAIM FORM IN TERMS OF THE PREFERENTIAL PROCUREMENT REGULATIONS 2017

This preference form must form part of all quotes invited. It contains general information and serves as a claim form for preference points for Broad-Based Black Economic Empowerment (B-BBEE) Status Level of Contribution

NB: BEFORE COMPLETING THIS FORM, BIDDERS MUST STUDY THE GENERAL CONDITIONS, DEFINITIONS AND DIRECTIVES APPLICABLE IN RESPECT OF B-BBEE, AS PRESCRIBED IN THE PREFERENTIAL PROCUREMENT REGULATIONS, 2017.

1. GENERAL CONDITIONS

- 1.1 The following preference point systems are applicable to all quotes:
- the 80/20 system for requirements with a Rand value of up to R50 000 000 (all applicable taxes included); and
- 1.2 The value of this quote is estimated to not exceed R50 000 000 (all applicable taxes included) and therefore the 80/20 preference point system shall be applicable.
- 1.3 Points for this quote shall be awarded for:
- (a) Price; and
 - (b) B-BBEE Status Level of Contributor.
- 1.4 The maximum points for this quote is allocated as follows:

| | POINTS |
|--|---------------|
| PRICE | 80 |
| B-BBEE STATUS LEVEL OF CONTRIBUTOR | 20 |
| Total points for Price and B-BBEE must not exceed | 100 |

- 1.5 Failure on the part of a bidder to submit proof of B-BBEE Status level of contributor together with the quote, will be interpreted to mean that preference points for B-BBEE status level of contribution are not claimed.
- 1.6 The purchaser reserves the right to require of a bidder, either before a quote is adjudicated or at any time subsequently, to substantiate any claim in regard to preferences, in any manner required by the purchaser.

2. DEFINITIONS

- (a) **"B-BBEE"** means broad-based black economic empowerment as defined in section 1 of the Broad-Based Black Economic Empowerment Act;
- (b) **"B-BBEE status level of contributor"** means the B-BBEE status of an entity in terms of a code of good practice on black economic empowerment, issued in terms of section 9(1) of the Broad-Based Black Economic Empowerment Act;
- (c) **"bid"** means a written offer in a prescribed or stipulated form in response to an invitation by an organ of state for the provision of goods or services, through price quotations, advertised competitive bidding processes or proposals;
- (d) **"Broad-Based Black Economic Empowerment Act"** means the Broad-Based Black Economic Empowerment Act, 2003 (Act No. 53 of 2003);
- (e) **"EME"** means an Exempted Micro Enterprise in terms of a code of good practice on black economic empowerment issued in terms of section 9 (1) of the Broad-Based Black Economic Empowerment Act;
- (f) **"functionality"** means the ability of a tenderer to provide goods or services in accordance with specifications as set out in the tender documents.
- (g) **"prices"** includes all applicable taxes less all unconditional discounts;
- (h) **"proof of B-BBEE status level of contributor"** means:
 - 1) B-BBEE Status level certificate issued by an authorized body or person;
 - 2) A sworn affidavit as prescribed by the B-BBEE Codes of Good Practice;
 - 3) Any other requirement prescribed in terms of the B-BBEE Act;
- (i) **"QSE"** means a qualifying small business enterprise in terms of a code of good practice on black economic empowerment issued in terms of section 9 (1) of the Broad-Based Black Economic Empowerment Act;
- (j) **"rand value"** means the total estimated value of a contract in Rand, calculated at the time of bid invitation, and includes all applicable taxes;

3. POINTS AWARDED FOR PRICE

3.1 THE 80/20 PREFERENCE POINT SYSTEMS

A maximum of 80 points is allocated for price on the following basis:

$$P_s = 80 \left(1 - \frac{P_t - P_{\min}}{P_{\min}} \right) \text{ Where}$$

- Ps = Points scored for price of bid under consideration
- Pt = Price of bid under consideration
- Pmin = Price of lowest acceptable bid

4. POINTS AWARDED FOR B-BBEE STATUS LEVEL OF CONTRIBUTOR

4.1 In terms of Regulation 6 (2) and 7 (2) of the Preferential Procurement Regulations, preference points must be awarded to a bidder for attaining the B-BBEE status level of contribution in accordance with the table below:

| B-BBEE Status Level of Contributor | Number of points (80/20 system) |
|------------------------------------|---------------------------------|
| 1 | 20 |
| 2 | 18 |
| 3 | 14 |
| 4 | 12 |
| 5 | 8 |
| 6 | 6 |
| 7 | 4 |
| 8 | 2 |
| Non-compliant contributor | 0 |

5. BID DECLARATION

5.1 Bidders who claim points in respect of B-BBEE Status Level of Contribution must complete the following:

6. B-BBEE STATUS LEVEL OF CONTRIBUTOR CLAIMED IN TERMS OF PARAGRAPHS 1.4 AND 4.1

6.1 B-BBEE Status Level of Contributor: =(maximum of 20 points)

(Points claimed in respect of paragraph 7.1 must be in accordance with the table reflected in paragraph 4.1 and must be substantiated by relevant proof of B-BBEE status level of contributor.

7. SUB-CONTRACTING

(Tick applicable box)

7.1 Will any portion of the contract be sub-contracted?

| | | | |
|-----|--------------------------|----|--------------------------|
| YES | <input type="checkbox"/> | NO | <input type="checkbox"/> |
|-----|--------------------------|----|--------------------------|

7.1.1 If yes, indicate:

- i) What percentage of the contract will be subcontracted.....%
- ii) The name of the sub-contractor.....
- iii) The B-BBEE status level of the sub-contractor.....

8. Whether the sub-contractor is an EME or QSE

(Tick applicable box)

iv) Specify, by ticking the appropriate box, if subcontracting with an enterprise in terms of Preferential Procurement Regulations,2017:

| | | | |
|-----|--------------------------|----|--------------------------|
| YES | <input type="checkbox"/> | NO | <input type="checkbox"/> |
|-----|--------------------------|----|--------------------------|

| Designated Group: An EME or QSE which is at last 51% owned by: | EME √ | QSE √ |
|---|----------|----------|
| Black people | | |
| Black people who are youth | | |
| Black people who are women | | |
| Black people with disabilities | | |
| Black people living in rural or underdeveloped areas or townships | | |
| Cooperative owned by black people | | |
| Black people who are military veterans | | |
| OR | | |
| Any EME | | |
| Any QSE | | |

9. DECLARATION WITH REGARD TO COMPANY/FIRM

9.1 Name of company/firm:.....

9.2 VAT registration number:.....

9.3 Company registration number:.....

9.4 TYPE OF COMPANY/ FIRM [TICK APPLICABLE BOX]

- Partnership/Joint Venture / Consortium
- One person business/sole propriety
- Close corporation
- Company
- (Pty) Limited

9.5 DESCRIBE PRINCIPAL BUSINESS ACTIVITIES

.....
.....

9.6 COMPANY CLASSIFICATION [TICK APPLICABLE BOX]

- Manufacturer
- Supplier
- Professional service provider
- Other service providers, e.g. transporter, etc.

9.7 Total number of years the company/firm has been in business:.....

9.8 I/we, the undersigned, who is / are duly authorised to do so on behalf of the company/firm, certify that the points claimed, based on the B-BBE status level of contributor indicated in paragraphs 1.4 and 6.1 of the foregoing certificate, qualifies the company/ firm for the preference(s) shown and I / we acknowledge that:

- i) The information furnished is true and correct;
- ii) The preference points claimed are in accordance with the General Conditions as indicated in paragraph 1 of this form;
- iii) In the event of a contract being awarded as a result of points claimed as shown in paragraphs 1.4 and 6.1, the contractor may be required to furnish documentary proof to the satisfaction of the purchaser that the claims are correct;
- iv) If the B-BBEE status level of contributor has been claimed or obtained on a fraudulent basis or any of the conditions of contract have not been fulfilled, the purchaser may, in addition to any other remedy it may have –
 - (a) disqualify the person from the bidding process;
 - (b) recover costs, losses or damages it has incurred or suffered as a result of that person's conduct;
 - (c) cancel the contract and claim any damages which it has suffered as a result of having to make less favourable arrangements due to such cancellation;
 - (d) recommend that the bidder or contractor, its shareholders and directors, or only the shareholders and directors who acted on a fraudulent basis, be restricted by the National Treasury from obtaining business from any organ of state for a period not exceeding 10 years, after the *audi alteram partem* (hear the other side) rule has been applied; and
 - (e) forward the matter for criminal prosecution.

| | |
|-----------|-------|
| WITNESSES | |
| 1. | |
| 2. | |

| | |
|----------------------------|-------|
| | |
| SIGNATURE(S) OF BIDDERS(S) | |
| DATE: | |
| ADDRESS | |
| | |
| | |