



Quotation Advert

Opening Date: 2020-05-05 

Closing Date: 2020-05-12 

Closing Time: 11:00

INSTITUTION DETAILS

Institution Name: Hlabisa hospital

Province: KwaZulu-Natal

Department or Entity: Department of Health

Division or section: Central Supply Chain Management

Place where goods / services is required HLABISA HOSPITAL

Date Submitted 2020-05-04 

ITEM CATEGORY AND DETAILS

Quotation Number: ZNQ:
003-20/21

Item Category: Services

Item Description: MAJOR SERVICE FOR DIESEL TANK

Quantity (if supplies)

COMPULSORY BRIEFING SESSION / SITE VISIT

Select Type: Not Applicable

Date : 

Time:

Venue:

QUOTES CAN BE COLLECTED FROM: 60 SAUNDERS STREET HLABISA HOSPITAL SCM OFFICE

QUOTES SHOULD BE DELIVERED TO: 60 SAUNDERS STREET HLABISA HOSPITAL MAINGATE TENDERBOX

ENQUIRIES REGARDING THE ADVERT MAY BE DIRECTED TO:

Name: MR AN SITHOLE

Email: hlabisa.quotations@kznhealth.gov.za

Contact Number:

035 838 8625/8780/8776 OR OUR FAX NUMBER IS 035 838 1959

Finance Manager Name:

MISS NB MASONDO

Finance Manager Signature:

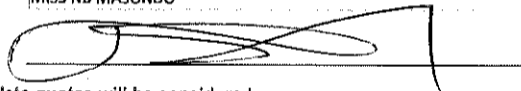
A handwritten signature in black ink, appearing to be 'MISS NB MASONDO', written over a horizontal line. The signature is stylized and somewhat cursive.

No late quotes will be considered



health

Department:
Health
PROVINCE OF KWAZULU-NATAL

HLABISA DISTRICT HOSPITAL

MAINTENANCE DEPARTMENT

Physical Address: 60 saunder street, hlabisa, 3739

Postal Address: P/Bag x 5001, hlabisa

Tel035 838 8808: Fax035 838 1117 Email:

Enquiries: Ms S.R Shabalala

EXT No.: 8808

Section: Maintenance

MAJOR SERVICE OF DIESEL TANK

1. Minimum requirement

- Service provider must have valid Tax Clearance Certificate.
- Service provider must have valid CIDB ME contractor
- Service provider must have registered with central supplier data base.
- Valid BEE certificate.
- Service provider must attached letter of good standing.
- Service provider must fill contract form ZNB 5730/30/-H accordingly.
- Service provider to report at Maintenance and complete relevant register for payment purposes.
- Service provider to provide after service report and quote together with the invoice for service where applicable.
- Duties must be available on the CSD (**Industry Classification Information**)
- Service provider to attach a certificate of handling dangerous gases

2. Documents required when after service is done:

The contractor shall submit the invoice with the following documents for the payment approval, if this document is not submitted we are going to take as un-finalized project.

- Report of the service as per unit and institution
- Signed and stamp scheduler
- Signed job cards by maintenance officer
- Original Tax Invoice
- Before and After oil samples must submitted in Maintenance section together with Laboratory document

Signature: _____

Date: _____

20/04/14

DOOSAN INFRACORE GENERATOR ENGINE

DP222LC

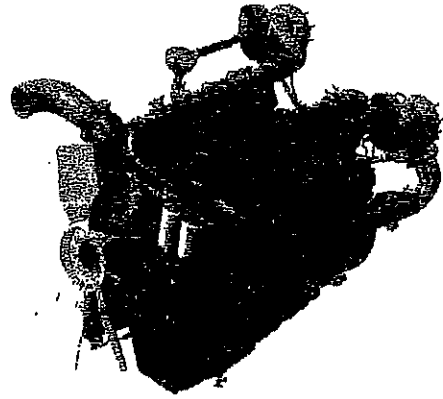

Ratings (kWm/PS)	Gross Engine Output - without Cooling Fan		Net Engine Output - with Cooling Fan	
	Standby	Prime	Standby	Prime
1500rpm(50Hz)	723/983	657/894	699/950	633/861
1800rpm(60Hz)	828/1126	763/1023	790/1074	715/972

* 50Hz : DP222LCF, 60Hz : DP222LCS

Ratings Definitions

The power ratings of Emergency Standby and Prime are in accordance with ISO 8528.

Fuel Stop power in accordance with ISO 3046.

Electric power(kW_e) should be estimated by considering generator efficiency, cooling fan power loss and power derating due to altitude and ambient temperature.

STANDBY POWER RATING is applicable for supplying emergency power for the duration of the utility power outage. No overload capability is available for this rating. A standby rated engine should be sized for a maximum of an 70% average load factor and 200 hours of operation per year. This includes less than 25 hours per year at the Standby Power rating.

PRIME POWER RATING is available for an unlimited of hours per year in variable load application. Variable load should not exceed a 70% average of the Prime Power rating during any operating period of 24 hours. The Total operating time at 100% Prime Power shall not exceed 500 hours per year. A 10% overload capability is available for a period of 1 hour within a 12 hour period of operation. Total operating time at the 10% overload power shall not exceed 25 hours per year.

◎ GENERAL ENGINE DATA

○ Engine Model	DP222LC
○ Engine Type	4-Cycle, V-type, 12-Cylinder, Turbo charged & intercooled (air to air)
○ Bore x stroke	128 x 142 mm
○ Displacement	21.927 liters
○ Compression ratio	15 : 1
○ Rotation	Counter clockwise viewed from Flywheel
○ Firing order	1-12-5-8-3-10-6-7-2-11-4-9
○ Injection timing	21°±1° BTDC @ 1800 rpm, 19°±1° BTDC @ 1500 rpm
○ Dry weight	1,420 kg(with Fan)
○ Dimension (LxWxH)	1,738 x 1,389 x 1,258 mm
○ Fly wheel housing	SAE NO.1M
○ Fly wheel	Clutch NO.14M
○ Number of teeth on flywheel	160

◎ ENGINE MOUNTING

○ Maximum Bending Moment at Rear Face to Block	1,325 N.m
--	-----------

◎ EXHAUST SYSTEM

○ Maximum Back Pressure	5.9 kPa
-------------------------	---------

◎ AIR INDUCTION SYSTEM

○ Maximum Intake Air Restriction	
. With Clean Filter Element	2.16 kPa
. With Dirty Filter Element	6.23 kPa
○ Max. static pressure after Radiator	0.125 kPa

◎ COOLING SYSTEM

Water circulation by centrifugal pump on engine.	
○ Cooling method	Fresh water forced circulation
○ Coolant capacity	Engine Only : Approx. 23 lit, With Radiator(*Air On 43°C) : Approx 114 lit.
○ Coolant flow rate	660 liters / min @ 1800 rpm, 550 liters / min @ 1500 rpm
○ Pressure Cap	49 kPa
○ Water Temperature	
- Maximum for standby and Prime	103°C
- Before start of full load	40.0°C
○ Water pump	Centrifugal type driven by belt
○ Thermostat Type and Range	Wax – pellet type, Opening temp. 71°C , Full open temp. 85°C
○ Cooling fan	Blower type, plastic , 916 mm diameter, 9 blades
○ Max. external coolant system restriction	Not available

* Two radiator options are provided, based on allowable maximum Air temperature On radiator inlet (Air On) : Air On 43°C / Air On 52°C
 - ATB(Ambient Temperature before Boiling) of generator set varies depending on the engine room ventilation design, even if the same radiator applied.
 Adequate selection of radiator options by means of the cooling test is highly recommended, and generator set makers are responsible for the selection.

◎ LUBRICATION SYSTEM

Force-feed lubrication by gear pump, lubricating oil cooling in cooling water circuit of engine.	
○ Lub. Method	Fully forced pressure feed type
○ Oil pump	Gear type driven by crank-shaft gear
○ Oil filter	Full flow, cartridge type
○ Oil capacity	Max. 40 liters , Min. 27 liters
○ Lub oil pressure	Idle Speed : Min 100 kPa Governed Speed : Min 250 kPa
○ Maximum oil temperature	120°C
○ Angularity limit	Front down 10 deg , Front up 10 deg , Side to side 22.5 deg
○ Lubrication oil	Refer to Operation Manual

◎ FUEL SYSTEM

Bosch type in-line pump with integrated, electromagnetic actuator.	
○ Injection pump	Bosch in-line "P" type
○ Governor	Electric type
○ Speed drop	G2 Class (ISO 8528)
○ Feed pump	Mechanical type in Inj pump.
○ Injection nozzle	Multi hole type
○ Opening pressure	28 MPa
○ Fuel filter	Full flow, cartridge type with water drain valve.
○ Maximum fuel inlet restriction	30 kPa
○ Maximum fuel return restriction	60 kPa
○ Fuel feed pump Capacity	630 liters / hr
○ Used fuel	Diesel fuel oil

◎ ELECTRICAL SYSTEM

○ Battery Charging Alternator	27.5V x 45A alternator
○ Voltage regulator	Built-in type IC regulator
○ Starting motor	24V x 7.0 kW
○ Battery Voltage	24V
○ Battery Capacity	2 x 200 Ah (recommended)
○ Starting aid (Option)	Block heater

◎ VALVE SYSTEM

o Type	Overhead valve type	
o Number of valve	Intake 1, exhaust 1 per cylinder	
o Valve lash at cold	Intake 0.25 mm, Exhaust 0.35 mm	
o Valve timing	Opening	Close
- Intake valve	24 deg. BTDC	36 deg. ABDC
- Exhaust valve	63 deg. BBDC	27 deg. ATDC

◎ PERFORMANCE DATA

o Governed Engine speed	rpm	Prime Power		Standby Power	
		1500	1800	1500	1800
o Engine Idle Speed	rpm	800	800	800	800
o Over speed limit	rpm	1650	1980	1650	1980
o Gross Engine Power Output	kW	667	753	723	828
	PS	894	1023	983	1126
o Break Mean effective pressure	MPa	2.39	2.29	2.63	2.52
o Mean Piston Speed	m/s	7.1	8.5	7.1	8.5
o Friction Power	kW	48	66	48	66
	PS	65.3	89.7	65.3	89.7
o Specific fuel consumption					
25% load	liters/hr			45.6	53.3
50% load	liters/hr	42.1	49.1	86.4	99.3
75% load	liters/hr	79.3	91.3	129.1	147.2
100% load	liters/hr	119.1	134.4	172.8	203.8
o Fan Power	kW	161.0	183.2	24	38
o Sound Pressure at 1m from the each side of Cylinder Block (without Fan)	dB(A)	100.14	102.11	100.14	102.11

The all data and the specific fuel consumption are based on ISO 3046/1, Standard reference conditions are in accordance with 298 K(25° Celsius) air temperature, 100kPa(1000mbar) air pressure, 60% relative humidity, 110m(361ft) altitude.

◎ Engine Data with Dry Type Exhaust Manifold

o Intake Air Flow	m3/min	42.2	55.2	45.4	59.4
o Exhaust gas temp. after turbo.	°C	493	477	519	499
o Exhaust Gas Flow	m3/min	119	152	132	168
Heat Rejection to Exhaust	kW	596	678	639	754
Heat Rejection to Coolant	kW	285	324	306	361
Heat Rejection to Intercooler	kW	145	166	156	184
Radiated Heat to Ambient	kW	60	69	65	77
ooling water circulation	liters/min	590	660	590	680
ooling fan air flow	m3/min	860	1050	860	1050





Member of the CCK Group

1900 Ø 15 m³ Single Skin Aboveground Storage Tank

Tank Construction:

1	Description	15m ³ AST Single Skin Steel Tank
2	Drawing No	TBA
3	Construction Code	EN12295-2:2003
4	Diameter	1900mm
5	Overall Length	5820mm
6	Cylindrical Length	5220mm
7	Maximum Capacity	±15.530ltr
8	Net Working Capacity	93 - 94%

9	Tank Shell Material	EN10025 S235JR / S275JR / S355JR
	Thickness:	6mm
		DIN6608 / DIN6616-6619
10	Dished End Material	EN10025 S235JR / S275JR
	Thickness:	6mm

11	Operating Temperature	Ambient
12	Operating Pressure	Atmospheric
13	Vapour Pressure	0 - 75 kPa
14	Test Pressure (Dry Compressed Air)	45 - 50 kPa
15	Surface Treatment	Sigma Silver RAL7037
16	External Coating Test	DFT measurement (Base & Top Coat)
17	Internal Surface Preparation	Low Viscosity Oil & White Spirit Smear
18	Internal & External Surface Preparation	Aviation / Water Storage - Refer Notes
19	Internal Corrosion Protection	Gal Blast ISO8501-3 SA2.5 As per customer's requirements

Fittings / Accessories:

20	Flanges	ANSI ASA 150 - Raised faced
21	Piping	Schedule 40 (Alternatively as per drawing)
22	Bois & Nuts	M16 x 50 Zinc Plated
23	Gaskets	Nitrile Gasket (Imported) Alternative - Klingerall C4430 (Local)
24	Manway Construction	Neck: ID - 600mm Flange: Ø720mm PCD - 560mm 32 x Ø18 Lid: 720mm x 14mm Steel
25	Manway Material	EN10025 S235 / 275JR
26	Filler Connection	As per customer's specification
27	Interstitial Monitoring Connection	N/A
28	Dip, Vent, Suction Nozzle Arrangement	Refer Drawing
29	Interstitial Liquid	N/A
30	Interstitial Monitoring	N/A

Notes - Non-standard order/tank:

◎ DERATING FROM ISO 3046 STANDARD CONDITIONS

The maximum power is the STANDBY rating when assessing derate parameters.

Ambient temperature is air cleaner inlet temperature.

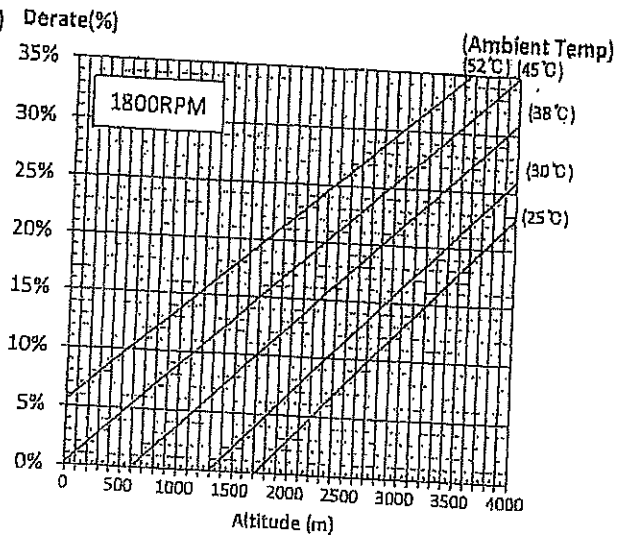
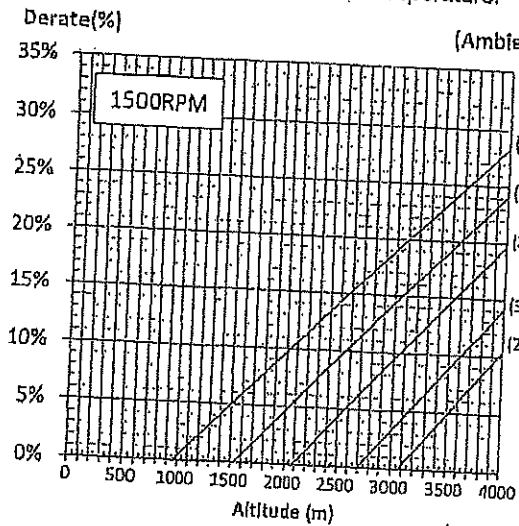

◎ ENGINE DIMENSION

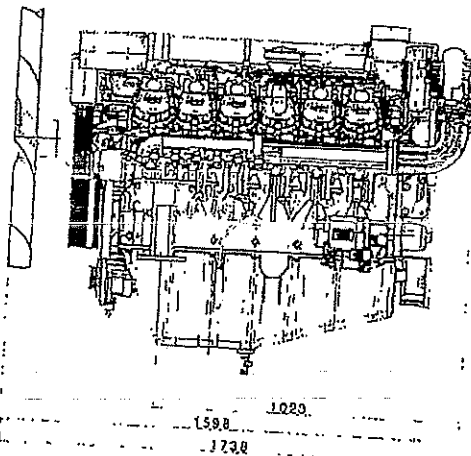
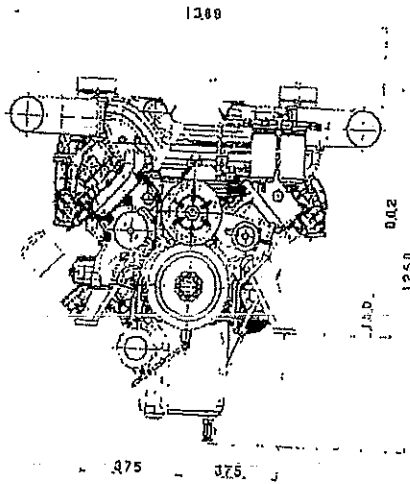

◆ CONVERSION TABLE

- in. = mm x 0.0394
- PS = kW x 1.3596
- psi = kg/cm² x 14.2233
- in³ = lit. x 61.02
- hp = PS x 0.98635
- lb = kg x 2.20462
- kW = kcal/sec x 0.239
- lb/ft = N.m x 0.737
- U.S. gal = lit. x 0.264
- kW = 0.2388 kcal/s
- lb/PS.h = g/kW.h x 0.00162
- cfm = m³/min x 35.336
- MPa = kPa x 1000 = bar x 10

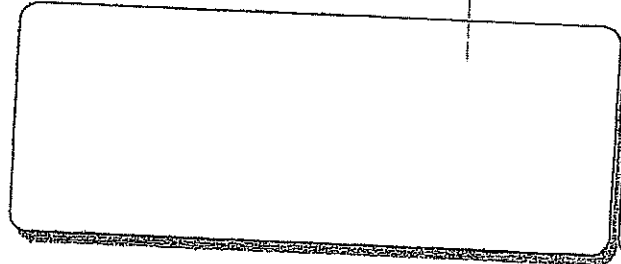

Doosan Infracore Co., Ltd.
 21st Floor, Doosan Tower, 18-12, Euljiro 6-ga,
 Jung-gu, Seoul, Korea.

TEL : +82-2-3398-8400 / FAX : +82-2-3398-8509
 E-mail : enginesales@doosan.com
 Web site : www.doosaninfracore.com

※ Specifications are subject to change without prior notice.



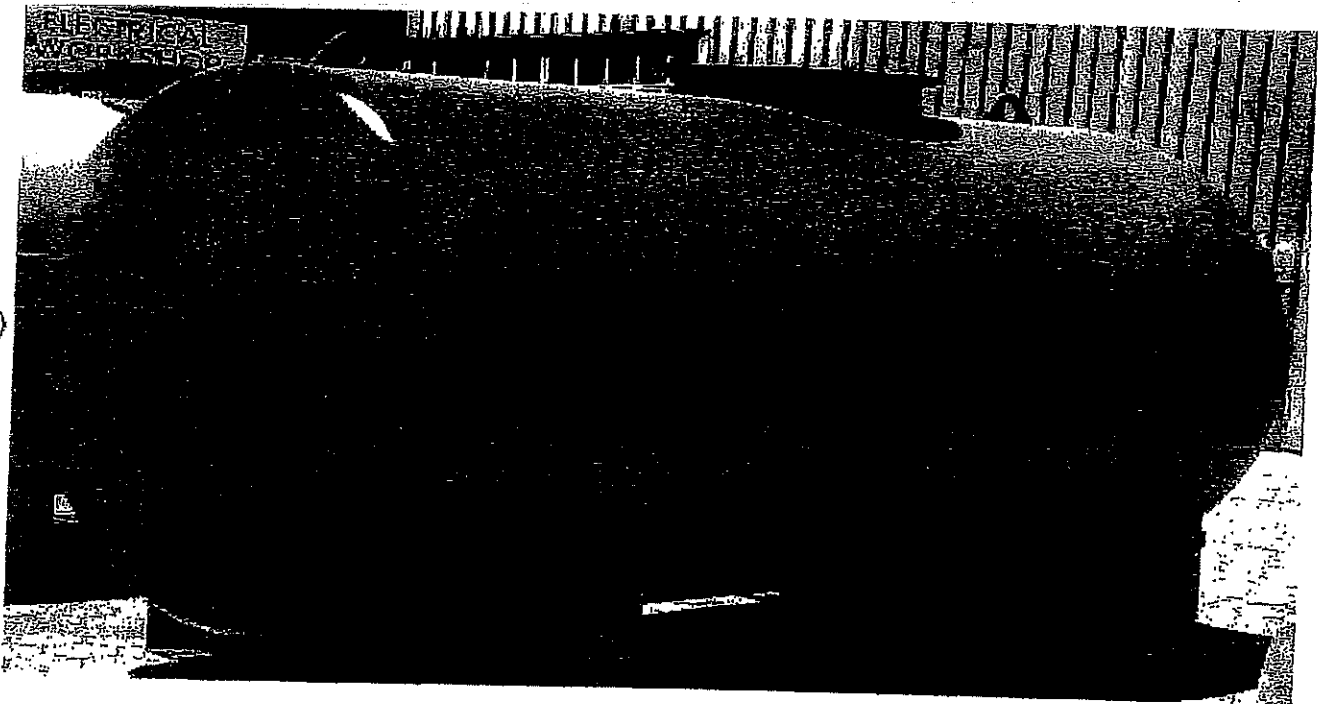
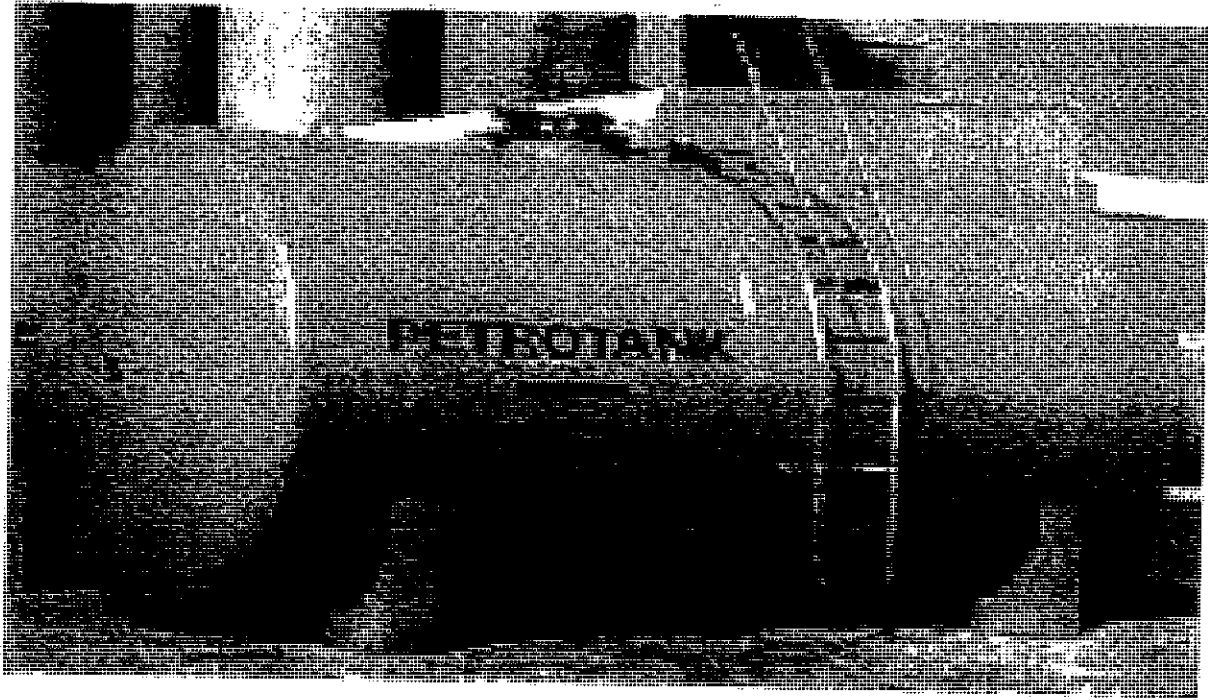

DECLARATION OF INTEREST

1. Any legal person, including persons employed by the state¹, or persons having a kinship with persons employed by the state, including a blood relationship, may make an offer or offers in terms of this invitation to quote (includes a price quotation, advertised competitive quote, limited quote or proposal). In view of possible allegations of favouritism, should the resulting quote, or part thereof, be awarded to persons employed by the state, or to persons connected with or related to them, it is required that the bidder or his/her authorised representative declare his/her position in relation to the evaluating/adjudicating authority where-
 - the bidder is employed by the state; and/or
 - the legal person on whose behalf the bidding document is signed, has a relationship with persons/a person who are/is involved in the evaluation and or adjudication of the quote(s), or where it is known that such a relationship exists between the person or persons for or on whose behalf the declarant acts and persons who are involved with the evaluation and or adjudication of the quote.

2. In order to give effect to the above, the following questionnaire must be completed and submitted with the quote.

- | | |
|--|---|
| 2.1. Full Name of bidder/representative..... | 2.4. Company Registration Number: |
| 2.2. Identity Number: | 2.5. Tax Reference Number: |
| 2.3. Position occupied in the Company (director, trustee, shareholder ²):..... | 2.6. VAT Registration Number: |

2.7. The names of all directors / trustees / shareholders / members, their individual identity numbers, tax reference numbers and, if applicable, employee / persal numbers must be indicated in paragraph 3 below. [TICK APPLICABLE]

2.8. Are you or any person connected with the bidder presently employed by the state? YES NO

2.8.1. If so, furnish the following particulars:
 Name of person / director / trustee / shareholder/ member:
 Name of state institution at which you or the person connected to the bidder is employed:.....
 Position occupied in the state institution:Any other particulars:.....

2.8.2. If you are presently employed by the state, did you obtain the appropriate authority to undertake remunerative work outside employment in the public sector? YES NO

2.8.2.1. If yes, did you attach proof of such authority to the quote document?

(Note: Failure to submit proof of such authority, where applicable, may result in the disqualification of the quote.)

2.8.2.2. If no, furnish reasons for non-submission of such proof:

2.9. Did you or your spouse, or any of the company's directors / trustees / shareholders / members or their spouses conduct business with the state in the previous twelve months? YES NO

2.9.1. If so, furnish particulars:.....

2.10. Do you, or any person connected with the bidder, have any relationship (family, friend, other) with a person employed by the state and who may be involved with the evaluation and or adjudication of this quote? YES NO

2.10.1. If so, furnish particulars:.....

2.11. Are you, or any person connected with the bidder, aware of any relationship (family, friend, other) between any other bidder and any person employed by the state who may be involved with the evaluation and or adjudication of this quote? YES NO

2.11.1. If so, furnish particulars:.....

2.12. Do you or any of the directors / trustees / shareholders / members of the company have any interest in any other related companies whether or not they are bidding for this contract? YES NO

2.12.1. If so, furnish particulars:.....

3. Full details of directors / trustees / members / shareholders.

NB: The Department Of Health will validate **details of directors / trustees / members / shareholders** on CSD. It is the suppliers' responsibility to ensure that their details are up-to-date and verified on CSD. If the Department cannot validate the **information** on CSD, the quote will not be considered and passed over as non-compliant according to National Treasury Instruction Note 4 (a) 2016/17.

4 DECLARATION

I, THE UNDERSIGNED (NAME).....CERTIFY THAT THE INFORMATION FURNISHED IN PARAGRAPHS 2.

I ACCEPT THAT THE STATE MAY REJECT THE QUOTE OR ACT AGAINST ME SHOULD THIS DECLARATION PROVE TO BE FALSE.

..... Name of bidder Signature Position Date
-------------------------	--------------------	-------------------	---------------

¹"State" means –

- | | |
|---|---|
| a) any national or provincial department, national or provincial public entity or constitutional institution within the meaning of the Public Finance Management Act, 1999 (Act No. 1 of 1999); | c) provincial legislature; |
| b) any municipality or municipal entity; | d) national Assembly or the national Council of provinces; or |
| | e) Parliament. |

²"Shareholder" means a person who owns shares in the company and is actively involved in the management of the enterprise or business and exercises control over the enterprise.

SPECIAL CONTRACT CONDITIONS OF QUOTATIONS

1. AMENDMENT OF CONTRACT

- 1.1. Any amendment to or renunciation of the provisions of the contract shall at all times be done in writing and shall be signed by both parties.

2. CHANGE OF ADDRESS

- 2.1. Bidders must advise the Department of Health (institution where the offer was submitted) should their address (*domicilium citandi et executandi*) details change from the time of bidding to the expiry of the contract.

3. GENERAL CONDITIONS ATTACHED TO THIS QUOTATION

- 3.1. The institution is under no obligation to accept the lowest or any quote.
- 3.2. The price quoted must include VAT (if VAT vendor). However, it must be noted that the department reserves the right to evaluate all quotations excluding VAT as some bidders may not be VAT vendors.
- 3.3. The bidder must ensure the correctness & validity of quote:
(i) *that the price(s), rate(s) & preference quoted cover all for the work/item (s) & accept that any mistakes regarding the price (s) & calculations will be at the bidder's risk*
- 3.4. The bidder must accept full responsibility for the proper execution & fulfilment of all obligations conditions devolving on under this agreement, as the Principal (s) liable for the due fulfilment of this contract.
- 3.5. This quotation will be evaluated based on the 80/20 points system, specification & correctness of information. All required documentation must be completed in full and submitted.
- 3.6. Offers must comply strictly with the specification.
- 3.7. Only offers that meet or are greater than the specification will be considered.
- 3.8. Late quotes will not be considered.
- 3.9. Expired product/s will not be accepted. All products supplied must be valid for a minimum period of six months.
- 3.10. A bidder not registered on the Central Suppliers Database or verification has failed will not be considered.
- 3.11. All delivery costs must be included in the quote price, for delivery at the prescribed destination.
- 3.12. Only firm prices will be accepted. Such prices must remain firm for the contract period. Non-firm prices (including rates of exchange variations) will not be considered.
- 3.13. In cases where different delivery points influence the pricing, a separate pricing schedule must be submitted for each delivery point.
- 3.14. In the event of a bidder having multiple quotes, only the cheapest according to specification will be considered. Furthermore a verification will be done to identify if bidders have multiple companies and are quoting (cover-quoting) for this bid. In such instances only the cheapest bid according to specification will be considered.

4. SPECIAL INSTRUCTIONS AND NOTICES TO BIDDERS REGARDING THE COMPLETION OF THIS QUOTATION.

- 4.1. Unless inconsistent with or expressly indicated otherwise by the context, the singular shall include the plural and vice versa and with words importing the masculine gender shall include the feminine and the neuter.
- 4.2. Under no circumstances whatsoever may the quotation/bid forms be retyped or redrafted. Photocopies of the original bid documentation may be used, but an original signature must appear on such photocopies.
- 4.3. The bidder is advised to check the number of pages and to satisfy himself that none are missing or duplicated.
- 4.4. Quotation submitted must be complete in all respects.
- 4.5. Any alteration made by the bidder must be initialled.
- 4.6. Use of correcting fluid is prohibited
- 4.7. Quotation will be opened in public as soon as practicable after the closing time of quotation.
- 4.8. Where practical, prices are made public at the time of opening quotations.
- 4.9. If it is desired to make more than one offer against any individual item, such offers should be given on a photocopy of the page in question. Clear indication thereof must be stated on the schedules attached.

5. SPECIAL INSTRUCTIONS REGARDING HAND DELIVERED QUOTATIONS

- 5.1. Quotation shall be lodged at the address indicated not later than the closing time specified for their receipt, and in accordance with the directives in the quotation documents.
- 5.2. Each quotation shall be addressed in accordance with the directives in the quotation documents and shall be lodged in a separate sealed envelope, with the name and address of the bidder, the quotation number and closing date indicated on the envelope. The envelope shall not contain documents relating to any quotation other than that shown on the envelope. If this provision is not complied with, such quotations/bids may be rejected as being invalid.
- 5.3. All quotations received in sealed envelopes with the relevant quotation numbers on the envelopes are kept unopened in safe custody until the closing time of the quotation/bids. Where, however, a quotation is received open, it shall be sealed. If it is received without a quotation/bid number on the envelope, it shall be opened, the quotation number ascertained, the envelope sealed and the quotation number written on the envelope.
- 5.4. A specific box is provided for the receipt of quotations, and no quotation found in any other box or elsewhere subsequent to the closing date and time of quotation will be considered.

- 5.5. No quotation/bid sent through the post will be considered if it is received after the closing date and time stipulated in the quotation documentation, and proof of posting will not be accepted as proof of delivery.
- 5.6. Quotation documents must not be included in packages containing samples. Such quotations may be rejected as being invalid.

6. SAMPLES

- 6.1. In the case of the quote document stipulating that samples are required, the supplier will be informed in due course when samples should be provided to the institution. (This decreases the time of safety and storage risk that may be incurred by the respective institution). The bidders sample will be retained if such bidder wins the contract.
 - (i) If a company/s who has not won the quote requires their samples, they must advise the institution in writing of such.
 - (ii) If samples are not collected within three months of close of quote the institution reserves the right to dispose of them at their discretion.
- 6.2. **Samples must be made available when requested in writing or if stipulated on the document.**
 - (i) If a Bidder fails to provide a sample of their product on offer for scrutiny against the set specification when requested, their offer will be rejected. All testing will be for the account of the bidder.

7. COMPULSORY SITE INSPECTION / BRIEFING SESSION

7.1. Bidders who fail to attend the compulsory meeting will be disqualified from the evaluation process.

- (i) The institution has determined that a compulsory site meeting take place
- (ii) Date Time Place

Institution Stamp: 	Institution Site Inspection / briefing session Official Full Name: Signature: Date:
----------------------------	--

8. STATEMENT OF SUPPLIES AND SERVICES

8.1. The contractor shall, when requested to do so, furnish particulars of supplies delivered or services executed. If he/she fails to do so, the Department may, without prejudice to any other rights which it may have, institute inquiries at the expense of the contractor to obtain the required particulars.

9. SUBMISSION AND COMPLETION OF SBD 6.1

9.1. Should a bidder wish to qualify for preference points they must complete a SBD 6.1 document. Failure by a bidder to provide all relevant information required, will result in such a bidder not being considered for preference point's allocation. The preferences applicable on the closing date will be utilized. Any changes after the closing date will not be considered for that particular quote.

10. TAX COMPLIANCE REQUIREMENTS

- 10.1. In the event that the tax compliance status has failed on CSD, **it is the suppliers' responsibility to provide a SARS pin in order for the institution to validate the tax compliance status of the supplier.**
- 10.2. In the event that the institution cannot validate the suppliers' tax clearance on SARS as well as the Central Suppliers Database, **the quote will not be considered and passed over as non-compliant according to National Treasury Instruction Note 4 (a) 2016/17.**

11. TAX INVOICE

11.1. A tax invoice shall be in the currency of the Republic of South Africa and shall contain the following particulars:

- (i) the name, address and registration number of the supplier;
- (ii) the name and address of the recipient;
- (iii) an individual serialized number and the date upon which the tax invoice is issued;
- (iv) a description and quantity or volume of the goods or services supplied;
- (v) the official department order number issued to the supplier;
- (vi) the value of the supply, the amount of tax charged;
- (vii) the words tax invoice in a prominent place.

12. PATENT RIGHTS

The supplier shall indemnify the **KZN Department of Health** (hereafter known as the purchaser) against all third-party claims of infringement of patent, trademark, or industrial design rights arising from use of the goods or any part thereof by the purchaser.

13. PENALTIES

- 13.1. If at any time during the contract period, the service provider is unable to perform in a timely manner, the service provider must notify the institution in writing/email of the cause of and the duration of the delay. Upon receipt of the notification, the institution should evaluate the circumstances and, if deemed necessary, the institution may extend the service provider's time for performance.
- 13.2. In the event of delayed performance that extends beyond the delivery period, the institution is entitled to purchase commodities of a similar quantity and quality as a substitution for the outstanding commodities, without terminating the contract, as well as return commodities delivered at a later stage at the service provider's expense.
- 13.3. Alternatively, the institution may elect to terminate the contract and procure the necessary commodities in order to complete the contract. In the event that the contract is terminated the institution may claim damages from the service provider in the form of a penalty. The service provider's performance should be captured on the service provider database in order to determine whether or not the service provider should be awarded any contracts in the future.
- 13.4. If the supplier fails to deliver any or all of the goods or to perform the services within the period(s) specified in the contract, the purchaser shall, without prejudice to its other remedies under the contract, deduct from the contract price, as a penalty, a sum calculated on the delivered price of the delayed goods or unperformed services using the current prime interest rate calculated for each day of the delay until actual delivery or performance.

14. TERMINATION FOR DEFAULT

- 14.1. The purchaser, without prejudice to any other remedy for breach of contract, by written notice of default sent to the supplier, may terminate this contract in whole or in part:
 - (i) if the supplier fails to deliver any or all of the goods within the period(s) specified in the contract,
 - (ii) if the supplier fails to perform any other obligation(s) under the contract; or
 - (iii) if the supplier, in the judgment of the purchaser, has engaged in corrupt or fraudulent practices in competing for or in executing the contract.
- 14.2. In the event the purchaser terminates the contract in whole or in part; the purchaser may procure, upon such terms and in such manner as it deems appropriate, goods, works or services similar to those undelivered, and the supplier shall be liable to the purchaser for any excess costs for such similar goods, works or services.
- 14.3. Where the purchaser terminates the contract in whole or in part, the purchaser may decide to impose a restriction penalty on the supplier by prohibiting such supplier from doing business with the public sector for a period not exceeding 10 years.

15. FAILURE TO COMPLY WITH ABOVE WILL RESULT IN YOUR QUOTE BEING PASSED OVER.

PREFERENCE POINTS CLAIM FORM IN TERMS OF THE PREFERENTIAL PROCUREMENT REGULATIONS 2017

This preference form must form part of all quotes invited. It contains general information and serves as a claim form for preference points for Broad-Based Black Economic Empowerment (B-BBEE) Status Level of Contribution

NB: BEFORE COMPLETING THIS FORM, BIDDERS MUST STUDY THE GENERAL CONDITIONS, DEFINITIONS AND DIRECTIVES APPLICABLE IN RESPECT OF B-BBEE, AS PRESCRIBED IN THE PREFERENTIAL PROCUREMENT REGULATIONS, 2017.

1. GENERAL CONDITIONS

- 1.1 The following preference point systems are applicable to all quotes:
- the 80/20 system for requirements with a Rand value of up to R50 000 000 (all applicable taxes included); and
- 1.2 The value of this quote is estimated to not exceed R50 000 000 (all applicable taxes included) and therefore the 80/20 preference point system shall be applicable.
- 1.3 Points for this quote shall be awarded for:
- (a) Price; and
 - (b) B-BBEE Status Level of Contributor.
- 1.4 The maximum points for this quote is allocated as follows:

	POINTS
PRICE	80
B-BBEE STATUS LEVEL OF CONTRIBUTOR	20
Total points for Price and B-BBEE must not exceed	100

- 1.5 Failure on the part of a bidder to submit proof of B-BBEE Status level of contributor together with the quote, will be interpreted to mean that preference points for B-BBEE status level of contribution are not claimed.
- 1.6 The purchaser reserves the right to require of a bidder, either before a quote is adjudicated or at any time subsequently, to substantiate any claim in regard to preferences, in any manner required by the purchaser.

2. DEFINITIONS

- (a) **"B-BBEE"** means broad-based black economic empowerment as defined in section 1 of the Broad-Based Black Economic Empowerment Act;
- (b) **"B-BBEE status level of contributor"** means the B-BBEE status of an entity in terms of a code of good practice on black economic empowerment, issued in terms of section 9(1) of the Broad-Based Black Economic Empowerment Act;
- (c) **"bid"** means a written offer in a prescribed or stipulated form in response to an invitation by an organ of state for the provision of goods or services, through price quotations, advertised competitive bidding processes or proposals;
- (d) **"Broad-Based Black Economic Empowerment Act"** means the Broad-Based Black Economic Empowerment Act, 2003 (Act No. 53 of 2003);
- (e) **"EME"** means an Exempted Micro Enterprise in terms of a code of good practice on black economic empowerment issued in terms of section 9 (1) of the Broad-Based Black Economic Empowerment Act;
- (f) **"functionality"** means the ability of a tenderer to provide goods or services in accordance with specifications as set out in the tender documents.
- (g) **"prices"** includes all applicable taxes less all unconditional discounts;
- (h) **"proof of B-BBEE status level of contributor"** means:
 - 1) B-BBEE Status level certificate issued by an authorized body or person;
 - 2) A sworn affidavit as prescribed by the B-BBEE Codes of Good Practice;
 - 3) Any other requirement prescribed in terms of the B-BBEE Act;
- (i) **"QSE"** means a qualifying small business enterprise in terms of a code of good practice on black economic empowerment issued in terms of section 9 (1) of the Broad-Based Black Economic Empowerment Act;
- (j) **"rand value"** means the total estimated value of a contract in Rand, calculated at the time of bid invitation, and includes all applicable taxes;

3. POINTS AWARDED FOR PRICE

3.1 THE 80/20 PREFERENCE POINT SYSTEMS

A maximum of 80 points is allocated for price on the following basis:

$$P_s = 80 \left(1 - \frac{P_t - P_{\min}}{P_{\min}} \right) \text{ Where}$$

- P_s = Points scored for price of bid under consideration
- P_t = Price of bid under consideration
- P_{min} = Price of lowest acceptable bid

4. POINTS AWARDED FOR B-BBEE STATUS LEVEL OF CONTRIBUTOR

4.1 In terms of Regulation 6 (2) and 7 (2) of the Preferential Procurement Regulations, preference points must be awarded to a bidder for attaining the B-BBEE status level of contribution in accordance with the table below:

B-BBEE Status Level of Contributor	Number of points (80/20 system)
1	20
2	18
3	14
4	12
5	8
6	6
7	4
8	2
Non-compliant contributor	0

5. BID DECLARATION

5.1 Bidders who claim points in respect of B-BBEE Status Level of Contribution must complete the following:

6. B-BBEE STATUS LEVEL OF CONTRIBUTOR CLAIMED IN TERMS OF PARAGRAPHS 1.4 AND 4.1

6.1 B-BBEE Status Level of Contributor: =(maximum of 20 points)

(Points claimed in respect of paragraph 7.1 must be in accordance with the table reflected in paragraph 4.1 and must be substantiated by relevant proof of B-BBEE status level of contributor.

7. SUB-CONTRACTING

(Tick applicable box)

7.1 Will any portion of the contract be sub-contracted?

YES	NO
-----	----

7.1.1 If yes, indicate:

- i) What percentage of the contract will be subcontracted.....%
- ii) The name of the sub-contractor.....
- iii) The B-BBEE status level of the sub-contractor.....

8. Whether the sub-contractor is an EME or QSE

(Tick applicable box)

iv) Specify, by ticking the appropriate box, if subcontracting with an enterprise in terms of Preferential Procurement Regulations,2017:

YES	NO
-----	----

Designated Group: An EME or QSE which is at last 51% owned by:	EME	QSE
Black people	√	√
Black people who are youth		
Black people who are women		
Black people with disabilities		
Black people living in rural or underdeveloped areas or townships		
Cooperative owned by black people		
Black people who are military veterans		
OR		
Any EME		
Any QSE		

9. **DECLARATION WITH REGARD TO COMPANY/FIRM**

9.1 Name of company/firm:.....

9.2 VAT registration number:.....

9.3 Company registration number:.....

9.4 TYPE OF COMPANY/ FIRM [TICK APPLICABLE BOX]

- Partnership/Joint Venture / Consortium
- One person business/sole propriety
- Close corporation
- Company
- (Pty) Limited

9.5 DESCRIBE PRINCIPAL BUSINESS ACTIVITIES

.....
.....

9.6 COMPANY CLASSIFICATION [TICK APPLICABLE BOX]

- Manufacturer
- Supplier
- Professional service provider
- Other service providers, e.g. transporter, etc.

9.7 Total number of years the company/firm has been in business:.....

9.8 I/we, the undersigned, who is / are duly authorised to do so on behalf of the company/firm, certify that the points claimed, based on the B-BBE status level of contributor indicated in paragraphs 1.4 and 6.1 of the foregoing certificate, qualifies the company/ firm for the preference(s) shown and I / we acknowledge that:

- i) The information furnished is true and correct;
- ii) The preference points claimed are in accordance with the General Conditions as indicated in paragraph 1 of this form;
- iii) In the event of a contract being awarded as a result of points claimed as shown in paragraphs 1.4 and 6.1, the contractor may be required to furnish documentary proof to the satisfaction of the purchaser that the claims are correct;
- iv) If the B-BBEE status level of contributor has been claimed or obtained on a fraudulent basis or any of the conditions of contract have not been fulfilled, the purchaser may, in addition to any other remedy it may have –
 - (a) disqualify the person from the bidding process;
 - (b) recover costs, losses or damages it has incurred or suffered as a result of that person's conduct;
 - (c) cancel the contract and claim any damages which it has suffered as a result of having to make less favourable arrangements due to such cancellation;
 - (d) recommend that the bidder or contractor, its shareholders and directors, or only the shareholders and directors who acted on a fraudulent basis, be restricted by the National Treasury from obtaining business from any organ of state for a period not exceeding 10 years, after the *audi alteram partem* (hear the other side) rule has been applied; and
 - (e) forward the matter for criminal prosecution.

WITNESSES

1.

2.

.....
SIGNATURE(S) OF BIDDERS(S)

DATE:

ADDRESS.....
.....
.....