

SharePoint

Makhanya Phumla ▾ ?



KWAZULU-NATAL PROVINCE
HEALTH
REPUBLIC OF SOUTH AFRICA

KZN HEALTH

KZN Health Intranet

Search this site



HOME CORPORATE INFORMATION COMPONENTS DIRECTORY DISTRICT OFFICES HEALTH FACILITIES

KZN Health > Components > Supply Chain Management

AdvertQuote

KWAZULU-NATAL PROVINCE
HEALTH
REPUBLIC OF SOUTH AFRICA

Quotation Advert

Opening Date: 2022-10-28

Closing Date: 2022-11-03

Closing Time: 11:00

INSTITUTION DETAILS

Institution Name: Inanda CHC

Province: KwaZulu-Natal

Department or Entity: Department of Health

Division or section: Central Supply Chain Management

Place where goods / services is required INADA CHC

Date Submitted 2022-10-28

ITEM CATEGORY AND DETAILS

Quotation Number: ZNQ:
INA 232-22-23

Item Category: Services

Item Description: SUPPLY AND INSTALL MEDICAL WASH HAND BASIN

Quantity (if supplies)**COMPULSORY BRIEFING SESSION / SITE VISIT**

Select Type: Compulsory Site Visit

Date : 2022-10-31

Time: 09:30

Venue: INANDA CHC

QUOTES CAN BE COLLECTED FROM: DOWNLOAD FROM WEBSITE**QUOTES SHOULD BE DELIVERED TO:** INANDA CHC TENDER BOX**ENQUIRIES REGARDING THE ADVERT MAY BE DIRECTED TO:****Name:** MR D MSWELI**Email:****Contact Number:** 031-5190455

Finance Manager Name:

Mr C/ Zulu

Finance Manager Signature:

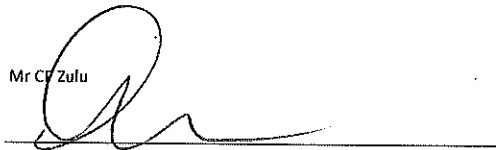

No late quotes will be considered

STANDARD QUOTE DOCUMENTATION OVER R30 000.00

YOU ARE HEREBY INVITED TO QUOTE FOR REQUIREMENTS AT: INANDA CHC
 DATE ADVERTISED: 28/10/2022 CLOSING DATE: 03/11/2022 CLOSING TIME: 11:00
 FACSIMILE NUMBER: E-MAIL ADDRESS:
 PHYSICAL ADDRESS: C 135 UMSHADO ROAD INANDA

QUOTE NUMBER: ZNQ / INA / 232 / 22 - 23

DESCRIPTION: SUPPLY AND INSTALL MEDICAL WASH HAND BASINS

CONTRACT PERIOD..... VALIDITY PERIOD 60 Days SARS PIN.....
(if applicable)

CENTRAL SUPPLIER DATABASE REGISTRATION (CSD) NO. M A A A

UNIQUE REGISTRATION REFERENCE

DEPOSITED IN THE QUOTE BOX SITUATED AT (STREET ADDRESS)
C 135 UMSHADO ROAD INANDA

Bidders should ensure that quotes are delivered timeously to the correct address. If the quote is late, it will not be accepted for consideration.

The quote box is open from 08:00 to 15:30.

QUOTATIONS MUST BE SUBMITTED ON THE OFFICIAL FORMS – (NOT TO BE RETYPED)

THIS QUOTE IS SUBJECT TO THE PREFERENTIAL PROCUREMENT POLICY FRAMEWORK ACT AND THE PREFERENTIAL PROCUREMENT REGULATIONS, 2011, THE GENERAL CONDITIONS OF CONTRACT (GCC) AND, IF APPLICABLE, ANY OTHER SPECIAL CONDITIONS OF CONTRACT.

THE FOLLOWING PARTICULARS MUST BE FURNISHED
(FAILURE TO DO SO MAY RESULT IN YOUR QUOTE BEING DISQUALIFIED)

NAME OF BIDDER

POSTAL ADDRESS

STREET ADDRESS

TELEPHONE NUMBER CODE.....NUMBER..... FACSIMILE NUMBER CODENUMBER.....

CELLPHONE NUMBER

E-MAIL ADDRESS

VAT REGISTRATION NUMBER (if VAT vendor)

HAS A B-BBEE STATUS LEVEL VERIFICATION CERTIFICATE BEEN SUBMITTED? (SBD 6.1) YES NO
[A B-BBEE STATUS LEVEL VERIFICATION CERTIFICATE/SWORN AFFIDAVIT (FOR EMEs & QSEs) MUST BE SUBMITTED TO QUALIFY FOR PREFERENCE POINTS FOR B-BBEE]

DESCRIPTION: SUPPLY AND INSTALL MEDICAL WASH HAND BASINS

SIGNATURE OF BIDDER DATE.....
 [By signing this document, I hereby agree to all terms and conditions]

CAPACITY UNDER WHICH THIS QUOTE IS SIGNED.....

Item No	Quantity	Description	Brand & model	Country of manufacture	Price	
					R	c
		SUUPPLY AND INSTALL MEDICAL WASH HAND				
		BASIN WITH ELBOW ACTION MIXER				
		SPECIFICATION ATTACHED				
VALUE ADDED TAX @ 15% (Only if VAT Vendor)						
TOTAL QUOTATION PRICE (VALIDITY PERIOD 60 Days)						

Does This Offer Comply With The Specification?	Does The Article Conform To The S.A.N.S. / S.A.B.S. Specification?
Is The Price Firm?	State Delivery Period, e.g., 1day, 1week

Enquiries regarding the <u>quote</u> may be directed to: Contact Person: Mr Dumisani Msweli Tel: 031-5190455	Enquiries regarding <u>technical information</u> may be directed to: Contact Person: Mr. B Khwela Tel: 031-519 0455
E-Mail Address:	

BIDDER'S DISCLOSURE

1. PURPOSE OF THE FORM

Any person (natural or juristic) may make an offer or offers in terms of this invitation to bid. In line with the principles of transparency, accountability, impartiality, and ethics as enshrined in the Constitution of the Republic of South Africa and further expressed in various pieces of legislation, it is required for the bidder to make this declaration in respect of the details required hereunder.

Where a person/s are listed in the Register for Tender Defaulters and / or the List of Restricted Suppliers, that person will automatically be disqualified from the bid process.

2. BIDDER'S DECLARATION

2.1. Is the bidder, or any of its directors / trustees / shareholders / members / partners or any person having a controlling interest¹ in the enterprise, employed by the state? **YES/NO**

2.1.1 If so, furnish particulars of the names, individual identity numbers, and, if applicable, state employee numbers of sole proprietor/ directors / trustees / shareholders / members/ partners or any person having a controlling interest in the enterprise, in table below.

Full Name	Identity Number	Name of State Institution

2.2. Do you, or any person connected with the bidder, have a relationship with any person who is employed by the procuring institution? **YES/NO**

2.2.1. If so, furnish particulars:

2.3. Does the bidder or any of its directors / trustees / shareholders / members / partners or any person having a controlling interest in the enterprise have any interest in any other related enterprise whether or not they are bidding for this contract? **YES/NO**

2.3.1. If so, furnish particulars:

3. DECLARATION

I, the undersigned,(name)..... in submitting the accompanying bid, do hereby make the following statements that I certify to be true and complete in every respect:

- 3.1. I have read and I understand the contents of this disclosure;
- 3.2. I understand that the accompanying bid will be disqualified if this disclosure is found not to be true and complete in every respect;
- 3.3. The bidder has arrived at the accompanying bid independently from, and without consultation, communication, agreement or arrangement with any competitor. However, communication between partners in a joint venture or consortium² will not be construed as collusive bidding.
- 3.4. In addition, there have been no consultations, communications, agreements or arrangements with any competitor regarding the quality, quantity, specifications, prices, including methods, factors or formulas used to calculate prices, market allocation, the intention or decision to submit or not to submit the bid, bidding with the intention not to win the bid and conditions or delivery particulars of the products or services to which this bid invitation relates.
- 3.5. The terms of the accompanying bid have not been, and will not be, disclosed by the bidder, directly or indirectly, to any competitor, prior to the date and time of the official bid opening or of the awarding of the contract.
- 3.6. There have been no consultations, communications, agreements or arrangements made by the bidder with any official of the procuring institution in relation to this procurement process prior to and during the bidding process except to provide clarification on the bid submitted where so required by the institution; and the bidder was not involved in the drafting of the specifications or terms of reference for this bid.
- 3.7. I am aware that, in addition and without prejudice to any other remedy provided to combat any restrictive practices related to bids and contracts, bids that are suspicious will be reported to the Competition Commission for investigation and possible imposition of administrative penalties in terms of section 59 of the Competition Act No 89 of 1998 and or may be reported to the National Prosecuting Authority (NPA) for criminal investigation and or may be restricted from conducting business with the public sector for a period not exceeding ten (10) years in terms of the Prevention and Combating of Corrupt Activities Act No 12 of 2004 or any other applicable legislation.

I CERTIFY THAT THE INFORMATION FURNISHED IN PARAGRAPHS 1, 2 and 3 ABOVE IS CORRECT.

I ACCEPT THAT THE STATE MAY REJECT THE BID OR ACT AGAINST ME IN TERMS OF PARAGRAPH 6 OF PFMA SCM INSTRUCTION 03 OF 2021/22 ON PREVENTING AND COMBATING ABUSE IN THE SUPPLY CHAIN MANAGEMENT SYSTEM SHOULD THIS DECLARATION PROVE TO BE FALSE.

.....
Name of Bidder

.....
Signature

.....
Position

.....
Date

¹ the power, by one person or a group of persons holding the majority of the equity of an enterprise, alternatively, the person/s having the deciding vote or power to influence or to direct the course and decisions of the enterprise.

² Joint venture or Consortium means an association of persons for the purpose of combining their expertise, property, capital, efforts, skill and knowledge in an activity for the execution of a contract.

GENERAL CONDITIONS OF CONTRACT

1. AMENDMENT OF CONTRACT

- 1.1. Any amendment to or renunciation of the provisions of the contract shall at all times be done in writing and shall be signed by both parties.

2. CHANGE OF ADDRESS

- 2.1. Bidders must advise the Department of Health (institution where the offer was submitted) should their address (*domicilium citandi et executandi*) details change from the time of bidding to the expiry of the contract.

3. GENERAL CONDITIONS ATTACHED TO THIS QUOTATION

- 3.1. The Department is under no obligation to accept the lowest or any quote.
- 3.2. The Department reserves the right to communicate in writing with vendors in cases where information is incomplete or where there are obscurities regarding technical aspects of the offer, to obtain confirmation of prices or preference claims in cases where it is evident that a typing, written, transfer or unit error has been made, to investigate the vendor's standing and ability to complete the supply/service satisfactorily.
- 3.3. **ALL DECISIONS TAKEN BY THE DEPARTMENT ARE FINAL, INCLUDING THE AWARD OR CANCELLATION OF THIS QUOTATION.**
- 3.4. The price quoted must include VAT (if VAT vendor).
- 3.5. Should a bidder become a VAT vendor after award or during the implementation of a contract, they may not request the VAT percentage from the Department as the service provider made an offer during the period they were not registered as a VAT vendor. The Department is only liable for any VAT from registered VAT vendors as originally stated on the quotation document.
- 3.6. The bidder must ensure the correctness & validity of the quotation:
 (i) *that the price(s), rate(s) & preference quoted cover all for the work/item (s) & accept that any mistakes regarding the price (s) & calculations will be at the bidder's risk*
 (ii) *it is the responsibility of the bidder to confirm receipt of their quotation and to keep proof thereof.*
- 3.7. The bidder must accept full responsibility for the proper execution & fulfilment of all obligations conditions devolving on under this agreement, as the Principal (s) liable for the due fulfilment of this contract.
- 3.8. This quotation will be evaluated based on the 80/20 points system, specification, correctness of information and/or functionality criteria. All required documentation must be completed in full and submitted.
- 3.9. Offers must comply strictly with the specification.
- 3.10. Only offers that meet or are greater than the specification will be considered.
- 3.11. Late offers will not be considered.
- 3.12. Expired product/s will not be accepted. All products supplied must be valid for a minimum period of six months.
- 3.13. Used/ second-hand products will not be accepted.
- 3.14. A bidder not registered on the Central Suppliers Database or whose verification has failed will not be considered.
- 3.15. All delivery costs must be included in the quoted price for delivery at the prescribed destination.
- 3.16. Only firm prices will be accepted. Such prices must remain firm for the contract period. Non-firm prices (including rates of exchange variations) will not be considered.
- 3.17. In cases where different delivery points influence the pricing, a separate pricing schedule must be submitted for each delivery point.
- 3.18. In the event of a bidder having multiple quotes, only the cheapest according to specification will be considered.
- 3.19. Verification will be conducted to identify if bidders have multiple companies and are cover-quoting for this bid.
- 3.20. In such instances, the Department reserves the right to immediately disqualify such bidders as cover-quoting is an offence that represents both corruption and acquisition fraud.

4. SPECIAL INSTRUCTIONS AND NOTICES TO BIDDERS REGARDING THE COMPLETION OF THIS QUOTATION.

- 4.1. Unless inconsistent with or expressly indicated otherwise by the context, the singular shall include the plural and vice versa and with words importing the masculine gender shall include the feminine and the neuter.
- 4.2. Under no circumstances whatsoever may the quotation/bid forms be retyped or redrafted. Photocopies of the original bid documentation may be used, but an original signature must appear on such photocopies.
- 4.3. The bidder is advised to check the number of pages and to satisfy himself that none are missing or duplicated.
- 4.4. Quotations submitted must be complete in all respects. However, where it is identified that information in a bidder's response, which does not affect the preference points or price, is incomplete in any respect, the said supplier meets all specification requirements and scores the highest points in terms of preference points and price, the Department reserves the right to request the bidder to complete/submit such information.
- 4.5. Any alteration made by the bidder must be initialled; failure to do so may render the response invalid.
- 4.6. Use of correcting fluid is prohibited and may render the response invalid.
- 4.7. Quotations will be opened in public as soon as practicable after the closing time of quotation.
- 4.8. Where practical, prices are made public at the time of opening quotations.
- 4.9. If it is desired to make more than one offer against any individual item, such offers should be given on a photocopy of the page in question. Clear indication thereof must be stated on the schedules attached.

4.10. The Department is under no obligation to pay suppliers in part for work done if the supplier can no longer fulfil their obligation.

5. SPECIAL INSTRUCTIONS REGARDING HAND DELIVERED QUOTATIONS

- 5.1. Quotation shall be lodged at the address indicated not later than the closing time specified for their receipt, and in accordance with the directives in the quotation documents.
- 5.2. Each quotation shall be addressed in accordance with the directives in the quotation documents and shall be lodged in a separate sealed envelope, with the name and address of the bidder, the quotation number and closing date indicated on the envelope. The envelope shall not contain documents relating to any quotation other than that shown on the envelope. If this provision is not complied with, such quotations/bids may be rejected as being invalid.
- 5.3. All quotations received in sealed envelopes with the relevant quotation numbers on the envelopes are kept unopened in safe custody until the closing time of the quotation/bids. Where, however, a quotation is received open, it shall be sealed. If it is received without a quotation/bid number on the envelope, it shall be opened, the quotation number ascertained, the envelope sealed and the quotation number written on the envelope.
- 5.4. A specific box is provided for the receipt of quotations, and no quotation found in any other box or elsewhere subsequent to the closing date and time of quotation will be considered.
- 5.5. No quotation/bid sent through the post will be considered if it is received after the closing date and time stipulated in the quotation documentation, and proof of posting will not be accepted as proof of delivery.
- 5.6. Quotation documents must not be included in packages containing samples. Such quotations may be rejected as being invalid.

6. SAMPLES

- 6.1. In the case of the quote document stipulating that samples are required, the supplier will be informed in due course when samples should be provided to the institution. (This decreases the time of safety and storage risk that may be incurred by the respective institution). The bidders sample will be retained if such bidder wins the contract.
 - (i) If a company/s who has not won the quote requires their samples, they must advise the institution in writing of such.
 - (ii) If samples are not collected within three months of close of quote the institution reserves the right to dispose of them at their discretion.
- 6.2. **Samples must be made available when requested in writing or if stipulated on the document.**
 - (i) If a Bidder fails to provide a sample of their product on offer for scrutiny against the set specification when requested, their offer will be rejected. All testing will be for the account of the bidder.

7. COMPULSORY SITE INSPECTION / BRIEFING SESSION

7.1. Bidders who fail to attend the compulsory meeting will be disqualified from the evaluation process.

- (i) The institution has determined that a compulsory site meeting take place
- (ii) Date ____ / ____ / ____ Time ____ : ____ Place _____

Institution Stamp:	Institution Site Inspection / briefing session Official Full Name: Signature: Date:
--------------------	--

8. STATEMENT OF SUPPLIES AND SERVICES

8.1. The contractor shall, when requested to do so, furnish particulars of supplies delivered or services executed. If he/she fails to do so, the Department may, without prejudice to any other rights which it may have, institute inquiries at the expense of the contractor to obtain the required particulars.

9. SUBMISSION AND COMPLETION OF SBD 6.1

9.1. Should a bidder wish to qualify for preference points they must complete a SBD 6.1 document. Failure by a bidder to provide all relevant information required, will result in such a bidder not being considered for preference point's allocation. The preferences applicable on the closing date will be utilized. Any changes after the closing date will not be considered for that particular quote.

10. TAX COMPLIANCE REQUIREMENTS

- 10.1. In the event that the tax compliance status has failed on CSD, **it is the suppliers' responsibility to provide a SARS pin in order for the institution to validate the tax compliance status of the supplier.**
- 10.2. In the event that the institution cannot validate the suppliers' tax clearance on SARS as well as the Central Suppliers Database, **the quote will not be considered and passed over as non-compliant according to National Treasury Instruction Note 4 (a) 2016/17.**

11. TAX INVOICE

11.1. A tax invoice shall be in the currency of the Republic of South Africa and shall contain the following particulars:

- (i) the name, address and registration number of the supplier;
- (ii) the name and address of the recipient;
- (iii) an individual serialized number and the date upon which the tax invoice is issued;
- (iv) a description and quantity or volume of the goods or services supplied;
- (v) the official department order number issued to the supplier;
- (vi) the value of the supply, the amount of tax charged;
- (vii) the words tax invoice in a prominent place.

12. PATENT RIGHTS

The supplier shall indemnify the **KZN Department of Health** (hereafter known as the purchaser) against all third-party claims of infringement of patent, trademark, or industrial design rights arising from use of the goods or any part thereof by the purchaser.

13. PENALTIES

- 13.1. If at any time during the contract period, the service provider is unable to perform in a timely manner, the service provider must notify the institution in writing/email of the cause of and the duration of the delay. Upon receipt of the notification, the institution should evaluate the circumstances and, if deemed necessary, the institution may extend the service provider's time for performance.
- 13.2. In the event of delayed performance that extends beyond the delivery period, the institution is entitled to purchase commodities of a similar quantity and quality as a substitution for the outstanding commodities, without terminating the contract, as well as return commodities delivered at a later stage at the service provider's expense.
- 13.3. Alternatively, the institution may elect to terminate the contract and procure the necessary commodities in order to complete the contract. In the event that the contract is terminated the institution may claim damages from the service provider in the form of a penalty. The service provider's performance should be captured on the service provider database in order to determine whether or not the service provider should be awarded any contracts in the future.
- 13.4. If the supplier fails to deliver any or all of the goods or to perform the services within the period(s) specified in the contract, the purchaser shall, without prejudice to its other remedies under the contract, deduct from the contract price, as a penalty, a sum calculated on the delivered price of the delayed goods or unperformed services using the current prime interest rate calculated for each day of the delay until actual delivery or performance.

14. TERMINATION FOR DEFAULT

- 14.1. The purchaser, without prejudice to any other remedy for breach of contract, by written notice of default sent to the supplier, may terminate this contract in whole or in part:
 - (i) if the supplier fails to deliver any or all of the goods within the period(s) specified in the contract,
 - (ii) if the supplier fails to perform any other obligation(s) under the contract; or
 - (iii) if the supplier, in the judgment of the purchaser, has engaged in corrupt or fraudulent practices in competing for or in executing the contract.
- 14.2. In the event the purchaser terminates the contract in whole or in part, the purchaser may procure, upon such terms and in such manner as it deems appropriate, goods, works or services similar to those undelivered, and the supplier shall be liable to the purchaser for any excess costs for such similar goods, works or services.
- 14.3. Where the purchaser terminates the contract in whole or in part, the purchaser may decide to impose a restriction penalty on the supplier by prohibiting such supplier from doing business with the public sector for a period not exceeding 10 years.

15. THE DEPARTMENT RESERVES THE RIGHT TO PASS OVER ANY QUOTATION WHICH FAILS TO COMPLY WITH THE ABOVE.

PREFERENCE POINTS CLAIM FORM IN TERMS OF THE PREFERENTIAL PROCUREMENT REGULATIONS 2017

This preference form must form part of all quotes invited. It contains general information and serves as a claim form for preference points for Broad-Based Black Economic Empowerment (B-BBEE) Status Level of Contribution

NB: BEFORE COMPLETING THIS FORM, BIDDERS MUST STUDY THE GENERAL CONDITIONS, DEFINITIONS AND DIRECTIVES APPLICABLE IN RESPECT OF B-BBEE, AS PRESCRIBED IN THE PREFERENTIAL PROCUREMENT REGULATIONS, 2017.

1. GENERAL CONDITIONS

1.1 The following preference point systems are applicable to all quotes:

- the 80/20 system for requirements with a Rand value of up to R50 000 000 (all applicable taxes included); and

1.2 The value of this quote is estimated to not exceed R50 000 000 (all applicable taxes included) and therefore the 80/20 preference point system shall be applicable.

1.3 Points for this quote shall be awarded for:

- (a) Price; and
- (b) B-BBEE Status Level of Contributor.

1.4 The maximum points for this quote is allocated as follows:

	POINTS
PRICE	80
B-BBEE STATUS LEVEL OF CONTRIBUTOR	20
Total points for Price and B-BBEE must not exceed	100

1.5 Failure on the part of a bidder to submit proof of B-BBEE Status level of contributor together with the quote, will be interpreted to mean that preference points for B-BBEE status level of contribution are not claimed.

1.6 The purchaser reserves the right to require of a bidder, either before a quote is adjudicated or at any time subsequently, to substantiate any claim in regard to preferences, in any manner required by the purchaser.

2. DEFINITIONS

- (a) **"B-BBEE"** means broad-based black economic empowerment as defined in section 1 of the Broad-Based Black Economic Empowerment Act;
- (b) **"B-BBEE status level of contributor"** means the B-BBEE status of an entity in terms of a code of good practice on black economic empowerment, issued in terms of section 9(1) of the Broad-Based Black Economic Empowerment Act;
- (c) **"bid"** means a written offer in a prescribed or stipulated form in response to an invitation by an organ of state for the provision of goods or services, through price quotations, advertised competitive bidding processes or proposals;
- (d) **"Broad-Based Black Economic Empowerment Act"** means the Broad-Based Black Economic Empowerment Act, 2003 (Act No. 53 of 2003);
- (e) **"EME"** means an Exempted Micro Enterprise in terms of a code of good practice on black economic empowerment issued in terms of section 9 (1) of the Broad-Based Black Economic Empowerment Act;
- (f) **"functionality"** means the ability of a tenderer to provide goods or services in accordance with specifications as set out in the tender documents.
- (g) **"prices"** includes all applicable taxes less all unconditional discounts;
- (h) **"proof of B-BBEE status level of contributor"** means:
 - 1) B-BBEE Status level certificate issued by an authorized body or person;
 - 2) A sworn affidavit as prescribed by the B-BBEE Codes of Good Practice;
 - 3) Any other requirement prescribed in terms of the B-BBEE Act;
- (i) **"QSE"** means a qualifying small business enterprise in terms of a code of good practice on black economic empowerment issued in terms of section 9 (1) of the Broad-Based Black Economic Empowerment Act;
- (j) **"rand value"** means the total estimated value of a contract in Rand, calculated at the time of bid invitation, and includes all applicable taxes;

3. POINTS AWARDED FOR PRICE

3.1 THE 80/20 PREFERENCE POINT SYSTEMS

A maximum of 80 points is allocated for price on the following basis:

$$P_s = 80 \left(1 - \frac{P_t - P_{\min}}{P_{\min}} \right) \text{ Where}$$

- P_s = Points scored for price of bid under consideration
- P_t = Price of bid under consideration
- P_{min} = price of lowest acceptable bid

4. POINTS AWARDED FOR B-BBEE STATUS LEVEL OF CONTRIBUTOR

4.1 In terms of Regulation 6 (2) and 7 (2) of the Preferential Procurement Regulations, preference points must be awarded to a bidder for attaining the B-BBEE status level of contribution in accordance with the table below:

B-BBEE Status Level of Contributor	Number of points (80/20 system)
1	20
2	18
3	14
4	12
5	8
6	6
7	4
8	2
Non-compliant contributor	0

5. BID DECLARATION

5.1 Bidders who claim points in respect of B-BBEE Status Level of Contribution must complete the following:

6. B-BBEE STATUS LEVEL OF CONTRIBUTOR CLAIMED IN TERMS OF PARAGRAPHS 1.4 AND 4.1

6.1 B-BBEE Status Level of Contributor: =(maximum of 20 points)

(Points claimed in respect of paragraph 7.1 must be in accordance with the table reflected in paragraph 4.1 and must be substantiated by relevant proof of B-BBEE status level of contributor.

7. SUB-CONTRACTING
(applicable box)

(Tick

YES		NO	
-----	--	----	--

7.1 Will any portion of the contract be sub-contracted?

7.1.1 If yes, indicate:

- i) What percentage of the contract will be subcontracted.....%
- ii) The name of the sub-contractor.....
- iii) The B-BBEE status level of the sub-contractor.....

3. Whether the sub-contractor is an EME or QSE

(Tick applicable box)

iv) Specify, by ticking the appropriate box, if subcontracting with an enterprise in terms of Preferential Procurement Regulations,2017:

YES		NO	
-----	--	----	--

Designated Group: An EME or QSE which is at least 51% owned by:	EME √	QSE √
Black people		
Black people who are youth		
Black people who are women		
Black people with disabilities		
Black people living in rural or underdeveloped areas or townships		
Cooperative owned by black people		
Black people who are military veterans		
OR		
Any EME		
Any QSE		

9. DECLARATION WITH REGARD TO COMPANY/FIRM

9.1 Name of company/firm:.....

9.2 VAT registration number:.....

9.3 Company registration number:.....

9.4 TYPE OF COMPANY/ FIRM [TICK APPLICABLE BOX]

- Partnership/Joint Venture / Consortium
- One person business/sole propriety
- Close corporation
- Company
- (Pty) Limited

9.5 DESCRIBE PRINCIPAL BUSINESS ACTIVITIES

.....

.....

9.6 COMPANY CLASSIFICATION [TICK APPLICABLE BOX]

- Manufacturer
- Supplier
- Professional service provider
- Other service providers, e.g. transporter, etc.

9.7 Total number of years the company/firm has been in business:.....

9.8 I/we, the undersigned, who is / are duly authorised to do so on behalf of the company/firm, certify that the points claimed, based on the B-BBE status level of contributor indicated in paragraphs 1.4 and 6.1 of the foregoing certificate, qualifies the company/ firm for the preference(s) shown and I / we acknowledge that:

- i) The information furnished is true and correct;
- ii) The preference points claimed are in accordance with the General Conditions as indicated in paragraph 1 of this form;
- iii) In the event of a contract being awarded as a result of points claimed as shown in paragraphs 1.4 and 6.1, the contractor may be required to furnish documentary proof to the satisfaction of the purchaser that the claims are correct;
- iv) If the B-BBEE status level of contributor has been claimed or obtained on a fraudulent basis or any of the conditions of contract have not been fulfilled, the purchaser may, in addition to any other remedy it may have –
 - (a) disqualify the person from the bidding process;
 - (b) recover costs, losses or damages it has incurred or suffered as a result of that person's conduct;
 - (c) cancel the contract and claim any damages which it has suffered as a result of having to make less favourable arrangements due to such cancellation;
 - (d) recommend that the bidder or contractor, its shareholders and directors, or only the shareholders and directors who acted on a fraudulent basis, be restricted by the National Treasury from obtaining business from any organ of state for a period not exceeding 10 years, after the *audi alteram partem* (hear the other side) rule has been applied; and
 - (e) forward the matter for criminal prosecution.

WITNESSES	
1.
2.

..... SIGNATURE(S) OF BIDDERS(S)
DATE:
ADDRESS.....
.....
.....



COMPLAINTS PROCESS FOR QUOTATIONS R2 000.00 TO R500 000.00 INCLUDING V.A.T

1. Supplier Submits Written Complaint / Objection

- Bidders aggrieved by decisions or actions taken by the Department or Institution during the SCM procurement process, must lodge a written complaint **immediately**.
- Complaints lodged two (2) or more days after the award will not be entertained.
- Complaints must be directed to the Responsibility Manager of the institution (Hospital or CHC) and District Finance Manager for District Offices.
- **It must be noted that this is not an appeals process and as such will not halt the procurement process.**

2. Institution Prepares Written Response to Complaint

- The Responsibility Manager, or his appointee, must prepare a response letter to the complainant.
- The complaint must be resolved within **60 days**.
- Should the complainant not be satisfied with the response, the matter will be referred to the District Finance Manager (applicable to all Hospitals and CHC) or District Manager (Applicable to all District Offices) for a final verdict.
- Should the complainant still not be satisfied with the response received, they may then seek legal recourse at their own expense.

Complaints or objections should be directed to:

Responsibility Manager:

Email Address:



health

Department:
Health
PROVINCE OF KWAZULU-NATAL

DIRECTORATE:

INANDA 'C' CHC

Physical Address : C 135 Mshado ROAD, Inanda
Physical Address : Private Bag x 04, Phoenix 434
Tel: 031 519 0455 Fax: 031 519 0460 Email: basil.khwela@kznhealth.gov.za
www.kznhealth.gov.za

Date:18.10.2022

Enquires: Basil Khwela

ZNQ-----

Supply and install medical wash hand basins with elbow action mixer

CIDB GRADING MINIMUM REQUIREMENT: 1GB

PROJECT SPECIFICATIONS

- Contractor to supply material and install WHB, Elbow action mixer including bottle traps, boll – o – stop and braded pipes.
- Contractor must remove all demanded WHB to replace with Medical WHB.
- The Medical WHB must be white in colour and allowing for Medical pillar mixer with aerated swan neck swivel outlet.
- WHB no provision for over flow, chain stay must be ideal for medical.
- No soap holder indents.
- 20 year guarantee against manufacturing defects.

Technical specification for WHB

Colour	White
Finish	Gloss
Material	Vitreous
Mounting Type	Wall Hung
Shape	Oval
Number of Bowls	1 Bowl
Overflow Protection	No
Height	210mm
Width	600mm

Length	492mm
Weight	14kg

➤ **Technical specification for Medical pillar mixer**

Medical pillar mixer	With aerated swan neck swill outlet 15mm, Chrome plated bottom connection with black nuts.
----------------------	--

BILL OF QUANTITY

BILL NO: 1

ITEM	Area	Description	UOM	QTY	RATE	AMOUNT
01.	Siphumelele Room 1	Medical pillar mixer		01		
	Siphumelele Room 2	Medical Pillar mixer, waste fitting and bottle trap		01		
02.	ARV Pharmacy	Medical pillar mixer		01		
03	Dental	Medical Pillar mixer		01		
04	Mental Health	Medical pillar mixer		01		
04	Physiotherapist	New Medical washing basin and Medical pillar mixer including waste fitting and bottle trap		01		

05	Eye clinic	New Medical washing basin and Medical pillar mixer including waste fitting and bottle trap		01		
06	Isolation room	Medical pillar mixer and bottle trap		01		
07	Emergency room	Medical pillar mixer		02		
08	Male Patients Toilet	Normal washing basin with fittings		01		
09	Room 6	Medical pillar mixer		04		
10	Family Planning	Medical pillar mixer		01		
11	EMTCT	Medical pillar mixer		01		
12	ANC	Medical pillar mixer		02		

SIGNITURE :



Date:

18/10/2022

510-21

Medical

Wall Mixer

Elbow action. Straight outlet. 1/4 turn ceramic disc. 1/2" BSP MI, SANS 226 TYPE 2

Includes

Wall type mixer with aerated fixed straight outlet
Ideal for medical, kitchen and industrial installations
1/4 turn ceramic disk headparts
DZR Brass, Chrome plated, JASWIC Listed

Spare parts

Blue headpart complete S-21-CLOCK
Red headpart complete S-21-ANTI
Blue headpart only S-21-1CLOCK
Red headpart only S-21-2ANTI
Elbow connections S-055-15, Aerator C-M22X1

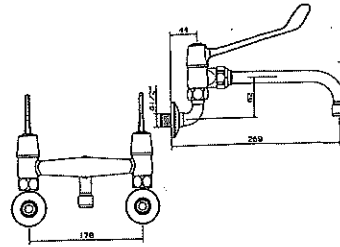

511-21

Medical

Wall Mixer

E/action with back plate. Straight outlet. 1/4 turn ceramic disc. 1/2" BSP MI, SANS 226 TYPE 2

Includes

Wall type mixer with re-inforcing back plate
Aerated fixed straight outlet
Re-inforcing backplate for additional rigidity
Ideal for medical, kitchen and industrial installations
1/4 turn ceramic disk headparts
DZR Brass, Chrome plated, JASWIC Listed

Spare parts

Blue headpart complete S-21-CLOCK
Red headpart complete S-21-ANTI
Blue headpart only S-21-1CLOCK
Red headpart only S-21-2ANTI
Elbow connections S-055/1-15, Aerator C-M22X1

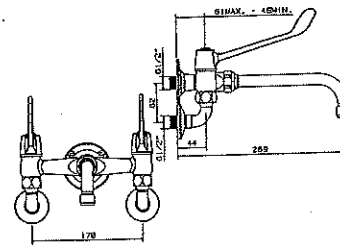

514-21B

Medical

Bottle Washer-Tap

Sidevalve with blue indice. 1/4 turn ceramic disc. 1/2" BSP male inlet, SANS 226 TYPE 2

Includes

Sidevalve, Sliding flange, Elbow action lever
Ideal for medical, kitchen and industrial installations
1/4 turn ceramic disk headpart (Clockwise closing)
DZR Brass, Chrome plated, JAWIC Listed

Spare parts

Blue headpart complete S-21-CLOCK
Blue headpart only S-21-1CLOCK

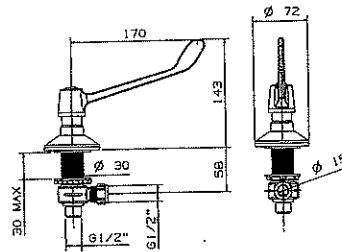

515-21

Medical

Pillar Mixer

With aerated swan neck swivel outlet. 1/4 turn ceramic disc. 1/2" BSP MI, SANS 226 TYPE 2

Includes

Pillar type mixer with aerated swan neck swivel outlet
Ideal for medical, kitchen and industrial installations
1/4 turn ceramic disk headparts
DZR Brass, Chrome plated, JASWIC Listed

Spare parts

Blue headpart complete S-21-CLOCK
Red headpart complete S-21-ANTI
Blue headpart only S-21-1CLOCK
Red headpart only S-21-2ANTI
Connection backnut 088-15
Swan neck swivel outlet S-044, Aerator C-M22X1

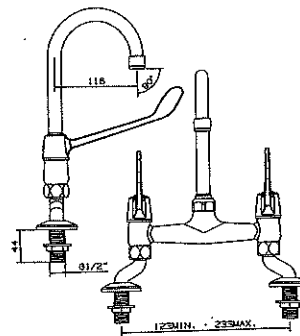

Medical Mixers

Wastes Traps & Overflows

Missile

TOILETS

BATHS

ESSOPIES

FIXTURES

WATER

CONNECTIONS

WATER

CONNECTIONS

WATER

CONNECTIONS

WATER

CONNECTIONS

WATER

CONNECTIONS

WATER

CONNECTIONS

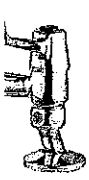

Water pressure systems not exceeding 4 bar (400 kPa) (60 psi), are recommended.

