



## Quotation Advert

**Opening Date:** 23/02/2023  
**Closing Date:** 01/03/2023  
**Closing Time:** 11:00

### INSTITUTION DETAILS

**Institution Name:** Amajuba District Office  
**Province:** KwaZulu-Natal  
**Department of entity:** Department of Health  
**Division or section:** Supply Chain Management  
**Place where goods/  
service is required:** AMAJUBA DISTRICT OFFICE  
**Date Submitted:** 23/02/2023

### ITEM CATEGORY AND DETAILS

**Quotation number:** AMA 028/22/23  
**Item Category:** Goods  
**Item Description:** UNIFORM  
**Quantity (if supplies):** AS PER ATTACHED LISTS

### COMPULSORY BRIEFING SESSION / SITE VISIT

**Select Type:** Not applicable

**QUOTES CAN BE COLLECTED FROM:** AMAJUBA DISTRICT OFFICE, 38 VOORTREKKER STREET, NEWCASTLE, 2940

**QUOTES SHOULD BE DELIVERED TO:** AMAJUBA DISTRICT OFFICE, 38 VOORTREKKER STREET, NEWCASTLE, 2940

### ENQUIRIES REGARDING ADVERT MAY BE DIRECTED TO:

**Name:** KHAYA MTHETHWA  
**Email:** khaya.mthethwa@kznhealth.gov.za  
**Contact number:** 034 328 7030

**Finance Manager Name:** C.N. KHUMALO

**Finance Manage signature:** 



OFFICIAL PRICE PAGE FOR QUOTATIONS OVER R2 000.01

QUOTE NUMBER: ZNQ / AMA / 028 / 22 / 23

DESCRIPTION: UNIFORM

PREFERENCE POINTS WILL BE ALLOCATED ACCORDING TO THE IMPLEMENTATION OF SPECIFIC GOALS IN TERMS OF PPR 2022:	POINTS ALLOCATED
Gender – full/partial/combination of points may be allocated to companies at least 51% Owned by Black Women	20

ICN NUMBER	QUANTITY	UNIT OF MEASURE	DESCRIPTION	BRAND & MODEL	COUNTRY OF MANUFACTUR E	PRICE	
						R	C
	on list	unit	UNIFORM A TOTAL (list attached and specification attached)				
	on list	unit	UNIFORM B TOTAL (list attached and specification attached)				
			Awarded supplier/s will be required to submit sample before final deliver.				
			Ownership verification may be conducted through CSD.				
			(Gender – full/partial/combination of points may be allocated to companies at least 51% Owned by Black Women)				
			Submit execution plan letter as indicated (no.5)0n evaluation criteria attached.				
			(FAXED, EMAILED OR HAND DELIVERED QUOTATIONS ARE ACCEPTED)				
			Please sign the Evaluation Criteria form attached				
VALUE ADDED TAX @ 15% (Only if VAT Vendor)							
TOTAL QUOTATION PRICE (VALIDITY PERIOD 60 Days)							

DOES THIS OFFER COMPLY WITH THE SPECIFICATION? YES / NO  
 IS THE PRICE FIRM? YES / NO  
 DOES THE ARTICLE CONFORM TO THE S.A.N.S. / S.A.B.S. SPECIFICATION? YES / NO

STATE DELIVERY PERIOD (E.G. 3 DAYS, 1 WEEK) \_\_\_\_\_

NAME OF BIDDER: \_\_\_\_\_

SIGNATURE OF BIDDER: \_\_\_\_\_  
 [By signing this document, I hereby agree to all terms and conditions]

CAPACITY UNDER WHICH THIS QUOTE IS SIGNED: \_\_\_\_\_

DATE: \_\_\_\_\_

**ISIFUNDAZWE SAKWAZULU-NATAL**

**EZEMPILO**

**23 FEB 2023**

**DEPARTMENT OF HEALTH**  
**PROVINCE OF KWAZULU-NATAL**

**BIDDER'S DISCLOSURE**

**1 PURPOSE OF THE FORM**

Any person (natural or juristic) may make an offer or offers in terms of this invitation to bid. In line with the principles of transparency, accountability, impartiality, and ethics as enshrined in the Constitution of the Republic of South Africa and further expressed in various pieces of legislation, it is required for the bidder to make this declaration in respect of the details required hereunder.

Where a person/s are listed in the Register for Tender Defaulters and / or the List of Restricted Suppliers, that person will automatically be disqualified from the bid process.

**2 BIDDER'S DECLARATION**

2.1. Is the bidder, or any of its directors / trustees / shareholders / members / partners or any person having a controlling interest<sup>1</sup> in the enterprise, employed by the state? **YES / NO**

2.1.1. If so, furnish particulars of the names, individual identity numbers, and, if applicable, state employee numbers of sole proprietor/ directors / trustees / shareholders / members/ partners or any person having a controlling interest in the enterprise, in table below.

FULL NAME	IDENTITY NUMBER	NAME OF STATE INSTITUTION

2.2. Do you, or any person connected with the bidder, have a relationship with any person who is employed by the procuring institution? **YES / NO**

2.2.1. If so, furnish particulars: \_\_\_\_\_

2.3. Does the bidder or any of its directors / trustees / shareholders / members / partners or any person having a controlling interest in the enterprise have any interest in any other related enterprise whether or not they are bidding for this contract? **YES / NO**

2.3.1. If so, furnish particulars: \_\_\_\_\_

**3 DECLARATION**

I, the undersigned, (name) \_\_\_\_\_ in submitting the accompanying bid, do hereby make the following statements that I certify to be true and complete in every respect:

- 3.1. I have read and I understand the contents of this disclosure;
- 3.2. I understand that the accompanying bid will be disqualified if this disclosure is found not to be true and complete in every respect;
- 3.3. The bidder has arrived at the accompanying bid independently from, and without consultation, communication, agreement or arrangement with any competitor. However, communication between partners in a joint venture or consortium<sup>2</sup> will not be construed as collusive bidding.
- 3.4. In addition, there have been no consultations, communications, agreements or arrangements with any competitor regarding the quality, quantity, specifications, prices, including methods, factors or formulas used to calculate prices, market allocation, the intention or decision to submit or not to submit the bid, bidding with the intention not to win the bid and conditions or delivery particulars of the products or services to which this bid invitation relates.
- 3.5. The terms of the accompanying bid have not been, and will not be, disclosed by the bidder, directly or indirectly, to any competitor, prior to the date and time of the official bid opening or of the awarding of the contract.
- 3.6. There have been no consultations, communications, agreements or arrangements made by the bidder with any official of the procuring institution in relation to this procurement process prior to and during the bidding process except to provide clarification on the bid submitted where so required by the institution; and the bidder was not involved in the drafting of the specifications or terms of reference for this bid.
- 3.7. I am aware that, in addition and without prejudice to any other remedy provided to combat any restrictive practices related to bids and contracts, bids that are suspicious will be reported to the Competition Commission for investigation and possible imposition of administrative penalties in terms of section 59 of the Competition Act No 89 of 1998 and or may be reported to the National Prosecuting Authority (NPA) for criminal investigation and or may be restricted from conducting business with the public sector for a period not exceeding ten (10) years in terms of the Prevention and Combating of Corrupt Activities Act No 12 of 2004 or any other applicable legislation.

I CERTIFY THAT THE INFORMATION FURNISHED IN PARAGRAPHS 1, 2 and 3 ABOVE IS CORRECT.

I ACCEPT THAT THE STATE MAY REJECT THE BID OR ACT AGAINST ME IN TERMS OF PARAGRAPH 6 OF PFMA SCM INSTRUCTION 03 OF 2021/22 ON PREVENTING AND COMBATING ABUSE IN THE SUPPLY CHAIN MANAGEMENT SYSTEM SHOULD THIS DECLARATION PROVE TO BE FALSE.

NAME OF BIDDER	SIGNATURE	POSITION	DATE
----------------	-----------	----------	------

1 the power, by one person or a group of persons holding the majority of the equity of an enterprise, alternatively, the person/s having the deciding vote or power to influence or to direct the course and decisions of the enterprise.  
 2 Joint venture or Consortium means an association of persons for the purpose of combining their expertise, property, capital, efforts, skill and knowledge in an activity for the execution of a contract.

GENERAL CONDITIONS OF CONTRACT

NOTES

The purpose of this document is to:

- (i) Draw special attention to certain general conditions applicable to government bids, contracts and orders; and
- (ii) To ensure that clients be familiar with regard to the rights and obligations of all parties involved in doing business with government.

In this document words in the singular also mean in the plural and vice versa and words in the masculine also mean in the feminine and neuter.

- The General Conditions of Contract will form part of all bid/quotation documents and may not be amended.
- Special Conditions of Contract (SCC) relevant to a specific bid, should be compiled separately for every bid (if applicable) and will supplement the General Conditions of Contract. Whenever there is a conflict, the provisions in the SCC shall prevail.

**1 Definitions**

The following terms shall be interpreted as indicated:

- 1.1. "Closing time" means the date and hour specified in the bidding documents for the receipt of bids.
- 1.2. "Contract" means the written agreement entered into between the purchaser and the supplier, as recorded in the contract form signed by the parties, including all attachments and appendices thereto and all documents incorporated by reference therein.
- 1.3. "Contract price" means the price payable to the supplier under the contract for the full and proper performance of his contractual obligations.
- 1.4. "Corrupt practice" means the offering, giving, receiving, or soliciting of any thing of value to influence the action of a public official in the procurement process or in contract execution.
- 1.5. "Countervailing duties" are imposed in cases where an enterprise abroad is subsidized by its government and encouraged to market its products internationally.
- 1.6. "Country of origin" means the place where the goods were mined, grown or produced or from which the services are supplied. Goods are produced when, through manufacturing, processing or substantial and major assembly of components, a commercially recognized new product results that is substantially different in basic characteristics or in purpose or utility from its components.
- 1.7. "Day" means calendar day.
- 1.8. "Delivery" means delivery in compliance of the conditions of the contract or order.
- 1.9. "Delivery ex stock" means immediate delivery directly from stock actually on hand.
- 1.10. "Delivery into consignees store or to his site" means delivered and unloaded in the specified store or depot or on the specified site in compliance with the conditions of the contract or order, the supplier bearing all risks and charges involved until the supplies are so delivered and a valid receipt is obtained.
- 1.11. "Dumping" occurs when a private enterprise abroad market its goods on own initiative in the RSA at lower prices than that of the country of origin and which have the potential to harm the local industries in the RSA
- 1.12. "Force majeure" means an event beyond the control of the supplier and not involving the supplier's fault or negligence and not foreseeable. Such events may include, but is not restricted to, acts of the purchaser in its sovereign capacity, wars or revolutions, fires, floods, epidemics, quarantine restrictions and freight embargoes.
- 1.13. "Fraudulent practice" means a misrepresentation of facts in order to influence a procurement process or the execution of a contract to the detriment of any bidder, and includes collusive practice among bidders (prior to or after bid submission) designed to establish bid prices at artificial non-competitive levels and to deprive the bidder of the benefits of free and open competition.
- 1.14. "GCC" means the General Conditions of Contract.
- 1.15. "Goods" means all of the equipment, machinery, and/or other materials that the supplier is required to supply to the purchaser under the contract.
- 1.16. "Imported content" means that portion of the bidding price represented by the cost of components, parts or materials which have been or are still to be imported (whether by the supplier or his subcontractors) and which costs are inclusive of the costs abroad, plus freight and other direct importation costs such as landing costs, dock dues, import duty, sales duty or other similar tax or duty at the South African place of entry as well as transportation and handling charges to the factory in the Republic where the supplies covered by the bid will be manufactured.
- 1.17. "Local content" means that portion of the bidding price which is not included in the imported content provided that local manufacture does take place.
- 1.18. "Manufacture" means the production of products in a factory using labour, materials, components and machinery and includes other related value-adding activities.
- 1.19. "Order" means an official written order issued for the supply of goods or works or the rendering of a service.
- 1.20. "Project site," where applicable, means the place indicated in bidding documents.
- 1.21. "Purchaser" means the organization purchasing the goods.
- 1.22. "Republic" means the Republic of South Africa.
- 1.23. "SCC" means the Special Conditions of Contract.
- 1.24. "Services" means those functional services ancillary to the supply of the goods, such as transportation and any other incidental services, such as installation, commissioning, provision of technical assistance, training, catering, gardening, security, maintenance and other such obligations of the supplier covered under the contract.
- 1.25. "Written" or "in writing" means handwritten in ink or any form of electronic or mechanical writing.

**2 Application**

- 2.1. These general conditions are applicable to all bids, contracts and orders including bids for functional and professional services, sales, hiring, letting and the granting or acquiring of rights, but excluding immovable property, unless otherwise indicated in the bidding documents.
- 2.2. Where applicable, special conditions of contract are also laid down to cover specific supplies, services or works.
- 2.3. Where such special conditions of contract are in conflict with these general conditions, the special conditions shall apply.

**3 General**

- 3.1. Unless otherwise indicated in the bidding documents, the purchaser shall not be liable for any expense incurred in the preparation and submission of a bid. Where applicable a non-refundable fee for documents may be charged.
- 3.2. With certain exceptions, invitations to bid are only published in the Government Tender Bulletin. The Government Tender Bulletin may be obtained directly from the Government Printer, Private Bag X85, Pretoria 0001, or accessed electronically from [www.treasury.gov.za](http://www.treasury.gov.za)



#### 4 Standards

- 4.1. The goods supplied shall conform to the standards mentioned in the bidding documents and specifications.

#### 5 Use of contract documents and information; inspection.

- 5.1. The supplier shall not, without the purchaser's prior written consent, disclose the contract, or any provision thereof, or any specification, plan, drawing, pattern, sample, or information furnished by or on behalf of the purchaser in connection therewith, to any person other than a person employed by the supplier in the performance of the contract. Disclosure to any such employed person shall be made in confidence and shall extend only so far as may be necessary for purposes of such performance.
- 5.2. The supplier shall not, without the purchaser's prior written consent, make use of any document or information mentioned in GCC clause 5.1 except for purposes of performing the contract.
- 5.3. Any document, other than the contract itself mentioned in GCC clause 5.1 shall remain the property of the purchaser and shall be returned (all copies) to the purchaser on completion of the supplier's performance under the contract if so required by the purchaser.
- 5.4. The supplier shall permit the purchaser to inspect the supplier's records relating to the performance of the supplier and to have them audited by auditors appointed by the purchaser, if so required by the purchaser.

#### 6 Patent rights

- 6.1. The supplier shall indemnify the purchaser against all third-party claims of infringement of patent, trademark, or industrial design rights arising from use of the goods or any part thereof by the purchaser.

#### 7 Performance security

- 7.1. Within thirty (30) days of receipt of the notification of contract award, the successful bidder shall furnish to the purchaser the performance security of the amount specified in SCC.
- 7.2. The proceeds of the performance security shall be payable to the purchaser as compensation for any loss resulting from the supplier's failure to complete his obligations under the contract.
- 7.3. The performance security shall be denominated in the currency of the contract, or in a freely convertible currency acceptable to the purchaser and shall be in one of the following forms:
- (a) a bank guarantee or an irrevocable letter of credit issued by a reputable bank located in the purchaser's country or abroad, acceptable to the purchaser, in the form provided in the bidding documents or another form acceptable to the purchaser; or
  - (b) a cashier's or certified cheque
- 7.4. The performance security will be discharged by the purchaser and returned to the supplier not later than thirty (30) days following the date of completion of the supplier's performance obligations under the contract, including any warranty obligations, unless otherwise specified in SCC.

#### 8 Inspections, tests and analyses

- 8.1. All pre-bidding testing will be for the account of the bidder.
- 8.2. If it is a bid condition that supplies to be produced or services to be rendered should at any stage during production or execution or on completion be subject to inspection, the premises of the bidder or contractor shall be open, at all reasonable hours, for inspection by a representative of the Department or an organization acting on behalf of the Department.
- 8.3. If there are no inspection requirements indicated in the bidding documents and no mention is made in the contract, but during the contract period it is decided that inspections shall be carried out, the purchaser shall itself make the necessary arrangements, including payment arrangements with the testing authority concerned.
- 8.4. If the inspections, tests and analyses referred to in clauses 8.2 and 8.3 show the supplies to be in accordance with the contract requirements, the cost of the inspections, tests and analyses shall be defrayed by the purchaser.
- 8.5. Where the supplies or services referred to in clauses 8.2 and 8.3 do not comply with the contract requirements, irrespective of whether such supplies or services are accepted or not, the cost in connection with these inspections, tests or analyses shall be defrayed by the supplier.
- 8.6. Supplies and services which are referred to in clauses 8.2 and 8.3 and which do not comply with the contract requirements may be rejected.
- 8.7. Any contract supplies may on or after delivery be inspected, tested or analyzed and may be rejected if found not to comply with the requirements of the contract. Such rejected supplies shall be held at the cost and risk of the supplier who shall, when called upon, remove them immediately at his own cost and forthwith substitute them with supplies which do comply with the requirements of the contract. Failing such removal the rejected supplies shall be returned at the suppliers cost and risk. Should the supplier fail to provide the substitute supplies forthwith, the purchaser may, without giving the supplier further opportunity to substitute the rejected supplies, purchase such supplies as may be necessary at the expense of the supplier.
- 8.8. The provisions of clauses 8.4 to 8.7 shall not prejudice the right of the purchaser to cancel the contract on account of a breach of the conditions thereof, or to act in terms of Clause 23 of GCC.

#### 9 Packing

- 9.1. The supplier shall provide such packing of the goods as is required to prevent their damage or deterioration during transit to their final destination, as indicated in the contract. The packing shall be sufficient to withstand, without limitation, rough handling during transit and exposure to extreme temperatures, salt and precipitation during transit, and open storage. Packing, case size and weights shall take into consideration, where appropriate, the remoteness of the goods' final destination and the absence of heavy handling facilities at all points in transit.
- 9.2. The packing, marking, and documentation within and outside the packages shall comply strictly with such special requirements as shall be expressly provided for in the contract, including additional requirements, if any, specified in SCC, and in any subsequent instructions ordered by the purchaser.

#### 10 Delivery and documents

- 10.1. Delivery of the goods shall be made by the supplier in accordance with the terms specified in the contract. The details of shipping and/or other documents to be furnished by the supplier are specified in SCC.
- 10.2. Documents to be submitted by the supplier are specified in SCC.

#### 11 Insurance

- 11.1. The goods supplied under the contract shall be fully insured in a freely convertible currency against loss or damage incidental to manufacture or acquisition, transportation, storage and delivery in the manner specified in the SCC.

**12 Transportation**

- 12.1. Should a price other than an all-inclusive delivered price be required, this shall be specified in the SCC.

**13 Incidental services**

- 13.1. The supplier may be required to provide any or all of the following services, including additional services, if any, specified in SCC:
- (a) performance or supervision of on-site assembly and/or commissioning of the supplied goods;
  - (b) furnishing of tools required for assembly and/or maintenance of the supplied goods;
  - (c) furnishing of a detailed operations and maintenance manual for each appropriate unit of the supplied goods;
  - (d) performance or supervision or maintenance and/or repair of the supplied goods, for a period of time agreed by the parties, provided that this service shall not relieve the supplier of any warranty obligations under this contract; and
  - (e) training of the purchaser's personnel, at the supplier's plant and/or on-site, in assembly, start-up, operation, maintenance, and/or repair of the
- 13.2. Prices charged by the supplier for incidental services, if not included in the contract price for the goods, shall be agreed upon in advance by the parties and shall not exceed the prevailing rates charged to other parties by the supplier for similar services.

**14 Spare parts**

- As specified in SCC, the supplier may be required to provide any or all of the following materials, notifications, and information pertaining to spare parts manufactured or distributed by the supplier:
- 14.1.
- (a) such spare parts as the purchaser may elect to purchase from the supplier, provided that this election shall not relieve the supplier of any warranty obligations under the contract; and
  - (b) in the event of termination of production of the spare parts:
    - (i) Advance notification to the purchaser of the pending termination, in sufficient time to permit the purchaser to procure needed requirements; and
    - (ii) following such termination, furnishing at no cost to the purchaser, the blueprints, drawings, and specifications of the spare parts, if requested.

**15 Warranty**

- 15.1. The supplier warrants that the goods supplied under the contract are new, unused, of the most recent or current models, and that they incorporate all recent improvements in design and materials unless provided otherwise in the contract. The supplier further warrants that all goods supplied under this contract shall have no defect, arising from design, materials, or workmanship (except when the design and/or material is required by the purchaser's specifications) or from any act or omission of the supplier, that may develop under normal use of the supplied goods in the conditions prevailing in the country of final destination.
- 15.2. This warranty shall remain valid for twelve (12) months after the goods, or any portion thereof as the case may be, have been delivered to and accepted at the final destination indicated in the contract, or for eighteen (18) months after the date of shipment from the port or place of loading in the source country, whichever period concludes earlier, unless specified otherwise in SCC.
- 15.3. The purchaser shall promptly notify the supplier in writing of any claims arising under this warranty.
- 15.4. Upon receipt of such notice, the supplier shall, within the period specified in SCC and with all reasonable speed, repair or replace the defective goods or parts thereof, without costs to the purchaser.
- 15.5. If the supplier, having been notified, fails to remedy the defect(s) within the period specified in SCC, the purchaser may proceed to take such remedial action as may be necessary, at the supplier's risk and expense and without prejudice to any other rights which the purchaser may have against the supplier under the contract.

**16 Payment**

- 16.1. The method and conditions of payment to be made to the supplier under this contract shall be specified in SCC.
- 16.2. The supplier shall furnish the purchaser with an invoice accompanied by a copy of the delivery note and upon fulfillment of other obligations stipulated in the contract.
- 16.3. Payments shall be made promptly by the purchaser, but in no case later than thirty (30) days after submission of an invoice or claim by the supplier.
- 16.4. Payment will be made in Rand unless otherwise stipulated in SCC.

**17 Prices**

- 17.1. Prices charged by the supplier for goods delivered and services performed under the contract shall not vary from the prices quoted by the supplier in his bid, with the exception of any price adjustments authorized in SCC or in the purchaser's request for bid validity extension, as the case may be.

**18 Contract amendments**

- 18.1. No variation in or modification of the terms of the contract shall be made except by written amendment signed by the parties concerned.

**19 Assignment**

- 19.1. The supplier shall not assign, in whole or in part, its obligations to perform under the contract, except with the purchaser's prior written consent.

**20 Subcontracts**

- 20.1. The supplier shall notify the purchaser in writing of all subcontracts awarded under this contracts if not already specified in the bid. Such notification, in the original bid or later, shall not relieve the supplier from any liability or obligation under the contract.

**21 Delays in the supplier's performance**

- 21.1. Delivery of the goods and performance of services shall be made by the supplier in accordance with the time schedule prescribed by the purchaser in the contract.
- 21.2. If at any time during performance of the contract, the supplier or its subcontractor(s) should encounter conditions impeding timely delivery of the goods and performance of services, the supplier shall promptly notify the purchaser in writing of the fact of the delay, its likely duration and its cause(s). As soon as practicable after receipt of the supplier's notice, the purchaser shall evaluate the situation and may at his discretion extend the supplier's time for performance, with or without the imposition of penalties, in which case the extension shall be ratified by the parties by amendment of contract.
- 21.3. No provision in a contract shall be deemed to prohibit the obtaining of supplies or services from a national department, provincial department, or a local authority.
- 21.4. The right is reserved to procure outside of the contract small quantities or to have minor essential services executed if an emergency arises, the supplier's point of supply is not situated at or near the place where the supplies are required, or the supplier's services are not readily available.

- 21.5. Except as provided under GCC Clause 25, a delay by the supplier in the performance of its delivery obligations shall render the supplier liable to the imposition of penalties, pursuant to GCC Clause 22, unless an extension of time is agreed upon pursuant to GCC Clause 21.2 without the application of penalties.
- 21.6. Upon any delay beyond the delivery period in the case of a supplies contract, the purchaser shall, without canceling the contract, be entitled to purchase supplies of a similar quality and up to the same quantity in substitution of the goods not supplied in conformity with the contract and to return any goods delivered later at the supplier's expense and risk, or to cancel the contract and buy such goods as may be required to complete the contract and without prejudice to his other rights, be entitled to claim damages from the supplier.
- 22 Penalties**
- 22.1. Subject to GCC Clause 25, if the supplier fails to deliver any or all of the goods or to perform the services within the period(s) specified in the contract, the purchaser shall, without prejudice to its other remedies under the contract, deduct from the contract price, as a penalty, a sum calculated on the delivered price of the delayed goods or unperformed services using the current prime interest rate calculated for each day of the delay until actual delivery or performance. The purchaser may also consider termination of the contract pursuant to GCC Clause 23.
- 23 Termination for default**
- 23.1. The purchaser, without prejudice to any other remedy for breach of contract, by written notice of default sent to the supplier, may terminate this contract in whole or in part:
- if the supplier fails to deliver any or all of the goods within the period(s) specified in the contract, or within any extension thereof granted by the purchaser pursuant to GCC Clause 21.2;
  - if the Supplier fails to perform any other obligation(s) under the contract; or
  - if the supplier, in the judgment of the purchaser, has engaged in corrupt or fraudulent practices in competing for or in executing the contract.
- 23.2. In the event the purchaser terminates the contract in whole or in part, the purchaser may procure, upon such terms and in such manner as it deems appropriate, goods, works or services similar to those undelivered, and the supplier shall be liable to the purchaser for any excess costs for such similar goods, works or services. However, the supplier shall continue performance of the contract to the extent not terminated.
- 23.3. Where the purchaser terminates the contract in whole or in part, the purchaser may decide to impose a restriction penalty on the supplier by prohibiting such supplier from doing business with the public sector for a period not exceeding 10 years.
- 23.4. If a purchaser intends imposing a restriction on a supplier or any person associated with the supplier, the supplier will be allowed a time period of not more than fourteen (14) days to provide reasons why the envisaged restriction should not be imposed. Should the supplier fail to respond within the stipulated fourteen (14) days the purchaser may regard the intended penalty as not objected against and may impose it on the supplier.
- 23.5. Any restriction imposed on any person by the Accounting Officer / Authority will, at the discretion of the Accounting Officer / Authority, also be applicable to any other enterprise or any partner, manager, director or other person who wholly or partly exercises or exercised or may exercise control over the enterprise of the first-mentioned person, and with which enterprise or person the first-mentioned person, is or was in the opinion of the Accounting Officer / Authority actively associated.
- 23.6. If a restriction is imposed, the purchaser must, within five (5) working days of such imposition, furnish the National Treasury, with the following information:
- the name and address of the supplier and / or person restricted by the purchaser;
  - the date of commencement of the restriction
  - the period of restriction; and
  - the reasons for the restriction.
- These details will be loaded in the National Treasury's central database of suppliers or persons prohibited from doing business with the public sector.
- 23.7. If a court of law convicts a person of an offence as contemplated in sections 12 or 13 of the Prevention and Combating of Corrupt Activities Act, No. 12 of 2004, the court may also rule that such person's name be endorsed on the Register for Tender Defaulters. When a person's name has been endorsed on the Register, the person will be prohibited from doing business with the public sector for a period not less than five years and not more than 10 years. The National Treasury is empowered to determine the period of restriction and each case will be dealt with on its own merits. According to section 32 of the Act the Register must be open to the public. The Register can be perused on the National Treasury website.
- 24 Anti-dumping and countervailing duties and rights**
- 24.1. When, after the date of bid, provisional payments are required, or antidumping or countervailing duties are imposed, or the amount of a provisional payment or anti-dumping or countervailing right is increased in respect of any dumped or subsidized import, the State is not liable for any amount so required or imposed, or for the amount of any such increase. When, after the said date, such a provisional payment is no longer required or any such anti-dumping or countervailing right is abolished, or where the amount of such provisional payment or any such right is reduced, any such favourable difference shall on demand be paid forthwith by the contractor to the State or the State may deduct such amounts from moneys (if any) which may otherwise be due to the contractor in regard to supplies or services which he delivered or rendered, or is to deliver or render in terms of the contract or any other contract or any other amount which may be due to him.
- 25 Force Majeure**
- 25.1. Notwithstanding the provisions of GCC Clauses 22 and 23, the supplier shall not be liable for forfeiture of its performance security, damages, or termination for default if and to the extent that his delay in performance or other failure to perform his obligations under the contract is the result of an event of force majeure.
- 25.2. If a force majeure situation arises, the supplier shall promptly notify the purchaser in writing of such condition and the cause thereof. Unless otherwise directed by the purchaser in writing, the supplier shall continue to perform its obligations under the contract as far as is reasonably practical, and shall seek all reasonable alternative means for performance not prevented by the force majeure event.
- 26 Termination for insolvency**
- 26.1. The purchaser may at any time terminate the contract by giving written notice to the supplier if the supplier becomes bankrupt or otherwise insolvent. In this event, termination will be without compensation to the supplier, provided that such termination will not prejudice or affect any right of action or remedy which has accrued or will accrue thereafter to the purchaser.
- 27 Settlement of Disputes**
- 27.1. If any dispute or difference of any kind whatsoever arises between the purchaser and the supplier in connection with or arising out of the contract, the parties shall make every effort to resolve amicably such dispute or difference by mutual consultation.



- 27.2. If, after thirty (30) days, the parties have failed to resolve their dispute or difference by such mutual consultation, then either the purchaser or the supplier may give notice to the other party of his intention to commence with mediation. No mediation in respect of this matter may be commenced unless such notice is given to the other party.
- 27.3. Should it not be possible to settle a dispute by means of mediation, it may be settled in a South African court of law.
- 27.4. Mediation proceedings shall be conducted in accordance with the rules of procedure specified in the SCC.
- 27.5. Notwithstanding any reference to mediation and/or court proceedings herein,  
(a) the parties shall continue to perform their respective obligations under the contract unless they otherwise agree; and  
(b) the purchaser shall pay the supplier any monies due the supplier.
- 28 Limitation of liability**
- 28.1. Except in cases of criminal negligence or willful misconduct, and in the case of infringement pursuant to Clause 6;  
(a) the supplier shall not be liable to the purchaser, whether in contract, tort, or otherwise, for any indirect or consequential loss or damage, loss of use, loss of production, or loss of profits or interest costs, provided that this exclusion shall not apply to any obligation of the supplier to pay penalties and/or damages to the purchaser; and  
(b) the aggregate liability of the supplier to the purchaser, whether under the contract, in tort or otherwise, shall not exceed the total contract price, provided that this limitation shall not apply to the cost of repairing or replacing defective equipment.
- 29 Governing language**
- 29.1. The contract shall be written in English. All correspondence and other documents pertaining to the contract that is exchanged by the parties shall also be written in English.
- 30 Applicable law**
- 30.1. The contract shall be interpreted in accordance with South African laws, unless otherwise specified in SCC.
- 31 Notices**
- 31.1. Every written acceptance of a bid shall be posted to the supplier concerned by registered or certified mail and any other notice to him shall be posted by ordinary mail to the address furnished in his bid or to the address notified later by him in writing and such posting shall be deemed to be proper service of such notice
- 31.2. The time mentioned in the contract documents for performing any act after such aforesaid notice has been given, shall be reckoned from the date of posting of such notice.
- 32 Taxes and duties**
- 32.1. A foreign supplier shall be entirely responsible for all taxes, stamp duties, license fees, and other such levies imposed outside the purchaser's country.
- 32.2. A local supplier shall be entirely responsible for all taxes, duties, license fees, etc., incurred until delivery of the contracted goods to the purchaser.
- 32.3. No contract shall be concluded with any bidder whose tax matters are not in order. Prior to the award of a bid the Department must be in possession of a tax clearance certificate, submitted by the bidder. This certificate must be an original issued by the South African Revenue Services.
- 33 National Industrial Participation (NIP) Programme**
- 33.1. The NIP Programme administered by the Department of Trade and Industry shall be applicable to all contracts that are subject to the NIP obligation.
- 34 Prohibition of Restrictive practices**
- 34.1. In terms of section 4 (1) (b) (iii) of the Competition Act No. 89 of 1998, as amended, an agreement between, or concerted practice by, firms, or a decision by an association of firms, is prohibited if it is between parties in a horizontal relationship and if a bidder (s) is / are or a contractor(s) was / were involved in collusive bidding (or bid rigging).
- 34.2. If a bidder(s) or contractor(s), based on reasonable grounds or evidence obtained by the purchaser, has / have engaged in the restrictive practice referred to above, the purchaser may refer the matter to the Competition Commission for investigation and possible imposition of administrative penalties as contemplated in the Competition Act No. 89 of 1998.
- 34.3. If a bidder(s) or contractor(s), has / have been found guilty by the Competition Commission of the restrictive practice referred to above, the purchaser may, in addition and without prejudice to any other remedy provided for, invalidate the bid(s) for such item(s) offered, and / or terminate the contract in whole or part, and / or restrict the bidder(s) or contractor(s) from conducting business with the public sector for a period not exceeding ten (10) years and / or claim damages from the bidder(s) or contractor(s) concerned.

**SPECIAL CONDITIONS OF CONTRACT**

**1. AMENDMENT OF CONTRACT**

- 1.1. Any amendment to or renunciation of the provisions of the contract shall at all times be done in writing and shall be signed by both parties.

**2. CHANGE OF ADDRESS**

- 2.1. Bidders must advise the Department of Health (institution where the offer was submitted) should their address (domicilium citandi et executandi) details change from the time of bidding to the expiry of the contract.

**3. GENERAL CONDITIONS ATTACHED TO THIS QUOTATION**

- 3.1. The Department is under no obligation to accept the lowest or any quote.
- 3.2. The Department reserves the right to communicate in writing with vendors in cases where information is incomplete or where there are obscurities regarding technical aspects of the offer, to obtain confirmation of prices or preference claims in cases where it is evident that a typing, written, transfer or unit error has been made, to investigate the vendor's standing and ability to complete the supply/service satisfactorily.
- 3.3. **ALL DECISIONS TAKEN BY THE DEPARTMENT ARE FINAL, INCLUDING THE AWARD OR CANCELLATION OF THIS QUOTATION.**
- 3.4. The price quoted must include VAT (if VAT vendor).
- 3.5. Should a bidder become a VAT vendor after award or during the implementation of a contract, they may not request the VAT percentage from the Department as the service provider made an offer during the period they were not registered as a VAT vendor. The Department is only liable for any VAT from registered VAT vendors as originally stated on the quotation document.
- 3.6. The bidder must ensure the correctness & validity of the quotation:  
(i) that the price(s), rate(s) & preference quoted cover all for the work/item (s) & accept that any mistakes regarding the price (s) & calculations will be at the bidder's risk;  
(ii) it is the responsibility of the bidder to confirm receipt of their quotation and to keep proof thereof.
- 3.7. The bidder must accept full responsibility for the proper execution & fulfilment of all obligations conditions devolving on under this agreement, as the Principal (s) liable for the due fulfilment of this contract.
- 3.8. This quotation will be evaluated based on the 80/20 points system, specification, correctness of information and/or functionality criteria. All required documentation must be completed in full and submitted.
- 3.9. Offers must comply strictly with the specification.
- 3.10. Only offers that meet or are greater than the specification will be considered.
- 3.11. Late offers will not be considered.
- 3.12. Expired product/s will not be accepted. All products supplied must be valid for a minimum period of six months.
- 3.13. Used/ second-hand products will not be accepted.
- 3.14. A bidder not registered on the Central Suppliers Database or whose verification has failed will not be considered.
- 3.15. All delivery costs must be included in the quoted price for delivery at the prescribed destination.
- 3.16. Only firm prices will be accepted. Such prices must remain firm for the contract period. Non-firm prices (including rates of exchange variations) will not be considered.
- 3.17. In cases where different delivery points influence the pricing, a separate pricing schedule must be submitted for each delivery point.
- 3.18. In the event of a bidder having multiple quotes, only the cheapest according to specification will be considered.
- 3.19. Verification will be conducted to identify if bidders have multiple companies and are cover-quoting for this bid.
- 3.20. In such instances, the Department reserves the right to immediately disqualify such bidders as cover-quoting is an offence that represents both corruption and acquisition fraud.

**4. SPECIAL INSTRUCTIONS AND NOTICES TO BIDDERS REGARDING THE COMPLETION OF THIS QUOTATION.**

- 4.1. Unless inconsistent with or expressly indicated otherwise by the context, the singular shall include the plural and vice versa and with words importing the masculine gender shall include the feminine and the neuter.
- 4.2. Under no circumstances whatsoever may the quotation/bid forms be retyped or redrafted. Photocopies of the original bid documentation may be used, but an original signature must appear on such photocopies.
- 4.3. The bidder is advised to check the number of pages and to satisfy himself that none are missing or duplicated.
- 4.4. Quotations submitted must be complete in all respects. However, where it is identified that information in a bidder's response, which does not affect the preference points or price, is incomplete in any respect, the said supplier meets all specification requirements and scores the highest points in terms of preference points and price, the Department reserves the right to request the bidder to complete/ submit such information.
- 4.5. Any alteration made by the bidder must be initialled; failure to do so may render the response invalid.
- 4.6. Use of correcting fluid is prohibited and may render the response invalid.
- 4.7. Quotations will be opened in public as soon as practicable after the closing time of quotation.
- 4.8. Where practical, prices are made public at the time of opening quotations.
- 4.9. If it is desired to make more than one offer against any individual item, such offers should be given on a photocopy of the page in question. Clear indication thereof must be stated on the schedules attached.
- 4.10. The Department is under no obligation to pay suppliers in part for work done if the supplier can no longer for fulfil their obligation.

**5. SPECIAL INSTRUCTIONS REGARDING HAND DELIVERED QUOTATIONS**

- 5.1. Quotation shall be lodged at the address indicated not later than the closing time specified for their receipt, and in accordance with the directives in the quotation documents.
- 5.2. Each quotation shall be addressed in accordance with the directives in the quotation documents and shall be lodged in a separate sealed envelope, with the name and address of the bidder, the quotation number and closing date indicated on the envelope. The envelope shall not contain documents relating to any quotation other than that shown on the envelope. If this provision is not complied with, such quotations/bids may be rejected as being invalid.
- 5.3. All quotations received in sealed envelopes with the relevant quotation numbers on the envelopes are kept unopened in safe custody until the closing time of the quotation/bids. Where, however, a quotation is received open, it shall be sealed. If it is received without a quotation/bid number on the envelope, it shall be opened, the quotation number ascertained, the envelope sealed and the quotation number written on the envelope.
- 5.4. A specific box is provided for the receipt of quotations, and no quotation found in any other box or elsewhere subsequent to the closing date and time of quotation will be considered.



5.6. Quotation documents must not be included in packages containing samples. Such quotations may be rejected as being invalid.

**6. SAMPLES**

6.1. In the case of the quote document stipulating that samples are required, the supplier will be informed in due course when samples should be provided to the institution. (This decreases the time of safety and storage risk that may be incurred by the respective institution). The bidders sample will be retained if such bidder wins the contract.

- (i) If a company/s who has not won the quote requires their samples, they must advise the institution in writing of such.
- (ii) If samples are not collected within three months of close of quote the institution reserves the right to dispose of them at their discretion.

6.2. **Samples must be made available when requested in writing or if stipulated on the document.**

If a Bidder fails to provide a sample of their product on offer for scrutiny against the set specification when requested, their offer will be rejected. All

- (i) testing will be for the account of the bidder.

**7. COMPULSORY SITE INSPECTION / BRIEFING SESSION**

7.1. Bidders who fail to attend the compulsory meeting will be disqualified from the evaluation process.

(i) The institution has determined that a compulsory site meeting will not take place.

(ii) Date:                    /                    /                    Time:                    :                    Place:                   

Institution Stamp:	Institution Site Inspection / briefing session Official:
	Full Name: _____
	Signature: _____
	Date: _____

**8. STATEMENT OF SUPPLIES AND SERVICES**

8.1. The contractor shall, when requested to do so, furnish particulars of supplies delivered or services executed. If he/she fails to do so, the Department may, without prejudice to any other rights which it may have, institute inquiries at the expense of the contractor to obtain the required particulars.

**9. SUBMISSION AND COMPLETION OF SBD 6.1**

9.1. Should a bidder wish to qualify for preference points they must complete a SBD 6.1 document. Failure by a bidder to provide all relevant information required, will result in such a bidder not being considered for preference point's allocation. The preferences applicable on the closing date will be utilized. Any changes after the closing date will not be considered for that particular quote.

**10. TAX COMPLIANCE REQUIREMENTS**

- 10.1. In the event that the tax compliance status has failed on CSD, it is the suppliers' responsibility to provide a SARS pin in order for the institution to validate the tax compliance status of the supplier.
- 10.2. In the event that the institution cannot validate the suppliers' tax clearance on SARS as well as the Central Suppliers Database, the quote will not be considered and passed over as non-compliant according to National Treasury Instruction Note 4 (a) 2016/17.

**11. TAX INVOICE**

11.1. A tax invoice shall be in the currency of the Republic of South Africa and shall contain the following particulars:

- (i) the name, address and registration number of the supplier;
- (ii) the name and address of the recipient;
- (iii) an individual serialized number and the date upon which the tax invoice
- (iv) a description and quantity or volume of the goods or services supplied;
- (v) the official department order number issued to the supplier;
- (vi) the value of the supply, the amount of tax charged;
- (vii) the words tax invoice in a prominent place.

**12. PATENT RIGHTS**

12.1. The supplier shall indemnify the KZN Department of Health (hereafter known as the purchaser) against all third-party claims of infringement of patent, trademark, or industrial design rights arising from use of the goods or any part thereof by the purchaser.

**13. PENALTIES**

- 13.1. If at any time during the contract period, the service provider is unable to perform in a timely manner, the service provider must notify the institution in writing/email of the cause of and the duration of the delay. Upon receipt of the notification, the institution should evaluate the circumstances and, if deemed necessary, the institution may extend the service provider's time for performance.
- 13.2. In the event of delayed performance that extends beyond the delivery period, the institution is entitled to purchase commodities of a similar quantity and quality as a substitution for the outstanding commodities, without terminating the contract, as well as return commodities delivered at a later stage at the service provider's expense.
- 13.3. Alternatively, the institution may elect to terminate the contract and procure the necessary commodities in order to complete the contract. In the event that the contract is terminated the institution may claim damages from the service provider in the form of a penalty. The service provider's performance should be captured on the service provider database in order to determine whether or not the service provider should be awarded any contracts in the future.
- 13.4. If the supplier fails to deliver any or all of the goods or to perform the services within the period(s) specified in the contract, the purchaser shall, without prejudice to its other remedies under the contract, deduct from the contract price, as a penalty, a sum calculated on the delivered price of the delayed goods or unperformed services using the current prime interest rate calculated for each day of the delay until actual delivery or performance.

**14. TERMINATION FOR DEFAULT**

- 14.1. The purchaser, without prejudice to any other remedy for breach of contract, by written notice of default sent to the supplier, may terminate this contract in whole or in part:
- (i) if the supplier fails to deliver any or all of the goods within the period(s) specified in the contract,
  - (ii) if the supplier fails to perform any other obligation(s) under the contract; or
  - (iii) if the supplier, in the judgment of the purchaser, has engaged in corrupt or fraudulent practices in competing for or in executing the contract.
- 14.2. In the event the purchaser terminates the contract in whole or in part, the purchaser may procure, upon such terms and in such manner as it deems appropriate, goods, works or services similar to those undelivered, and the supplier shall be liable to the purchaser for any excess costs for such similar goods, works or services.
- 14.3. Where the purchaser terminates the contract in whole or in part, the purchaser may decide to impose a restriction penalty on the supplier by prohibiting such supplier from doing business with the public sector for a period not exceeding 10 years.
- 15. THE DEPARTMENT RESERVES THE RIGHT TO PASS OVER ANY QUOTATION WHICH FAILS TO COMPLY WITH THE ABOVE.**

**PREFERENCE POINTS CLAIM FORM IN TERMS OF THE PREFERENTIAL PROCUREMENT REGULATIONS 2022**

This preference form must form part of all tenders invited. It contains general information and serves as a claim form for preference points for specific goals.

**NB: BEFORE COMPLETING THIS FORM, TENDERERS MUST STUDY THE GENERAL CONDITIONS, DEFINITIONS AND DIRECTIVES APPLICABLE IN RESPECT OF THE TENDER AND PREFERENTIAL PROCUREMENT REGULATIONS, 2022**

**1. GENERAL CONDITIONS**

- 1.1. The following preference point systems are applicable to invitations to tender:
- the 80/20 system for requirements with a Rand value of up to R50 000 000 (all applicable taxes included); and
  - the 90/10 system for requirements with a Rand value above R50 000 000 (all applicable taxes included).

1.2. The applicable preference point system for this tender is the 80/20 preference point system.

- 1.3. Points for this tender (even in the case of a tender for income-generating contracts) shall be awarded for:
- (a) Price; and
  - (b) Specific Goals.

1.4. The maximum points for this tender are allocated as follows:

	POINTS
PRICE	80
SPECIFIC GOALS	20
Total points for Price and Specific Goals	100

1.5. Failure on the part of a tenderer to submit proof or documentation required in terms of this tender to claim points for specific goals with the tender, will be interpreted to mean that preference points for specific goals are not claimed.

1.6. The organ of state reserves the right to require of a tenderer, either before a tender is adjudicated or at any time subsequently, to substantiate any claim in regard to preferences, in any manner required by the organ of state.

**4. DEFINITIONS**

- (a) "tender" means a written offer in the form determined by an organ of state in response to an invitation to provide goods or services through price quotations, competitive tendering process or any other method envisaged in legislation;
- (b) "price" means an amount of money tendered for goods or services, and includes all applicable taxes less all unconditional discounts;
- (c) "rand value" means the total estimated value of a contract in Rand, calculated at the time of bid invitation, and includes all applicable taxes;
- (d) "tender for income-generating contracts" means a written offer in the form determined by an organ of state in response to an invitation for the origination of income-generating contracts through any method envisaged in legislation that will result in a legal agreement between the organ of state and a third party that produces revenue for the organ of state, and includes, but is not limited to, leasing and disposal of assets and concession contracts, excluding direct sales and disposal of assets through public auctions; and
- (e) "the Act" means the Preferential Procurement Policy Framework Act, 2000 (Act No. 5 of 2000).

**3. FORMULAE FOR PROCUREMENT OF GOODS AND SERVICES**

**3.1. POINTS AWARDED FOR PRICE**

**3.1.1. THE 80/20 OR 90/10 PREFERENCE POINT SYSTEMS**

A maximum of 80 or 90 points is allocated for price on the following basis:

80/20

$$P_s = 80 \left( 1 - \frac{P_t - P_{min}}{P_{min}} \right)$$

OR

90/10

$$P_s = 90 \left( 1 - \frac{P_t - P_{min}}{P_{min}} \right)$$

Where

- $P_s$  = Points scored for price of tender under consideration
- $P_t$  = Price of tender under consideration
- $P_{min}$  = Price of lowest acceptable tender

**3.2. FORMULAE FOR DISPOSAL OR LEASING OF STATE ASSETS AND INCOME GENERATING PROCUREMENT**

**3.2.1. POINTS AWARDED FOR PRICE**

A maximum of 80 or 90 points is allocated for price on the following basis:

80/20

$$P_s = 80 \left( 1 + \frac{P_t - P_{max}}{P_{max}} \right)$$

OR

90/10

$$P_s = 90 \left( 1 + \frac{P_t - P_{max}}{P_{max}} \right)$$

Where

- $P_s$  = Points scored for price of tender under consideration
- $P_t$  = Price of tender under consideration
- $P_{max}$  = Price of highest acceptable tender

**4. POINTS AWARDED FOR SPECIFIC GOALS**

- 4.1. In terms of Regulation 4(2); 5(2); 6(2) and 7(2) of the Preferential Procurement Regulations, preference points must be awarded for specific goals stated in the tender. For the purposes of this tender the tenderer will be allocated points based on the goals stated in table 1 below as may be supported by proof/ documentation stated in the conditions of this tender:
- 4.2. In cases where organs of state intend to use Regulation 3(2) of the Regulations, which states that, if it is unclear whether the 80/20 or 90/10 preference point system applies, an organ of state must, in the tender documents, stipulate in the case of—
- (a) an invitation for tender for income-generating contracts, that either the 80/20 or 90/10 preference point system will apply and that the highest acceptable tender will be used to determine the applicable preference point system; or
  - (b) any other invitation for tender, that either the 80/20 or 90/10 preference point system will apply and that the lowest acceptable tender will be used to determine the applicable preference point system,
- then the organ of state must indicate the points allocated for specific goals for both the 90/10 and 80/20 preference point system.

**Table 1: Specific goals for the tender and points claimed are indicated per the table below.**

**Note to tenderers: The tenderer must indicate how they claim points for each preference point system.**

The specific goal/s allocated points in terms of this tender	Number of points allocated (80/20 system)	Number of points claimed (80/20 system)
Gender – full/partial/combination of points may be allocated to companies at least 51% Owned by Black Women	20	

**DECLARATION WITH REGARD TO COMPANY/FIRM**

- 4.3. Name of company/firm: \_\_\_\_\_
- 4.4. Company registration number: \_\_\_\_\_
- 4.5. TYPE OF COMPANY/ FIRM [tick applicable box]
- Partnership/Joint Venture / Consortium
  - One-person business/sole propriety
  - Close corporation
  - Public Company
  - Personal Liability Company
  - (Pty) Limited
  - Non-Profit Company
  - State Owned Company

- 4.6. I, the undersigned, who is duly authorised to do so on behalf of the company/firm, certify that the points claimed, based on the specific goals as advised in the tender, qualifies the company/ firm for the preference(s) shown and I acknowledge that:
- i) The information furnished is true and correct;
  - ii) The preference points claimed are in accordance with the General Conditions as indicated in paragraph 1 of this form;
  - iii) In the event of a contract being awarded as a result of points claimed as shown in paragraphs 1.4 and 4.2, the contractor may be required to furnish documentary proof to the satisfaction of the organ of state that the claims are correct;
  - iv) If the specific goals have been claimed or obtained on a fraudulent basis or any of the conditions of contract have not been fulfilled, the organ of state may, in addition to any other remedy it may have –
    - (a) disqualify the person from the tendering process;
    - (b) recover costs, losses or damages it has incurred or suffered as a result of that person's conduct;
    - (c) cancel the contract and claim any damages which it has suffered as a result of having to make less favourable arrangements due to such cancellation;
    - (d) recommend that the tenderer or contractor, its shareholders and directors, or only the shareholders and directors who acted on a fraudulent basis, be restricted from obtaining business from any organ of state for a period not exceeding 10 years, after the audi alteram partem (hear the other side) rule has been applied; and
    - (e) forward the matter for criminal prosecution, if deemed necessary.

\_\_\_\_\_  
SIGNATURE(S) OF TENDERER(S)

SURNAME AND NAME: \_\_\_\_\_

DATE: \_\_\_\_\_

ADDRESS: \_\_\_\_\_

\_\_\_\_\_

\_\_\_\_\_

## UNIFORM A - EMS GREEN TROUSER UNIFORM

DESCRIPTION	QUANTITY	UNIT PRICE	TOTAL
EMS GREEN TROUSERS UNIFORM 50% COTTON AND 50% POLYESTER, LIME AND SILVER STRIPES (MALE AND FEMALE), SIZES ATTACHED	84 TROUSERS		
TOTAL			

**EMS GREEN UNIFORM TROUSERS SIZES REQUESTED FOR EMS AMAJUBA DISTRICT**

**08 NOVEMBER 2022**

<b>SIZES REQUIRED</b>	<b>GENDER</b>	<b>QUANTITY REQUIRED</b>
40	MALE	8
42	MALES	08
42	FEMALE	28
44	FEMALE	20
44	MALE	08
46	FEMALE	08
52	MALE	04
<b>TOTAL</b>		<b>84</b>

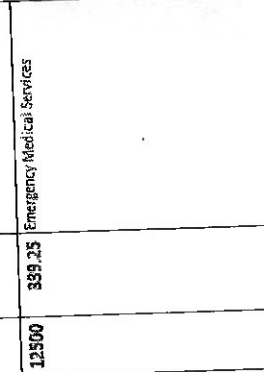
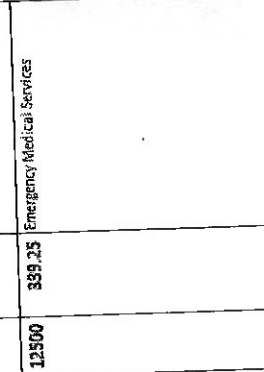

<p>122</p>	<p>12500</p>	<p>399.25</p>	<p>Emergency Medical Services</p>	
<p>122</p>	<p>12500</p>	<p>399.25</p>	<p>Emergency Medical Services</p>	

TROUSERS, OPERATIONS FEMALE SPECIFICATION; SEE EMS SPECIFICATION DOCUMENT FOR FULL SPECIFICATION (ENSO00) SIZES: 26 - 58 COLOUR: MEDICAL GREEN (PANTONE 349C / #008439 COLOUR HEX) MATERIAL: FIELD DRESS TEST REPORT NOT REQUIRED BUT PRE-PRODUCTION SAMPLE REQUIRED. WILL BE PROCURED AS A UNIT WITH MALE AND FEMALE TROUSERS, MALE AND FEMALE LONG SLEEVE AS WELL AS MALE AND FEMALE SHORT SLEEVE UNIFORM IN MEDICAL GREEN

*[Handwritten signature]*

Ready



N.T.P. / ARC TECHNOLOGY / BFP SAFETY GROUP / BOH ONMAS / CABIN MATTERS / 30 UNIFORMS / FRANCOLO / GRAND UNIFORM / 1 and 2 / NEW UNIT / ESD GARMENTS / LISA E.H.

100%

0235

3022



**KWAZULU-NATAL PROVINCE**

**HEALTH**  
REPUBLIC OF SOUTH AFRICA

**DIRECTORATE:**

**EMERGENCY MEDICAL SERVICES**

NO 5b faraday street Newcastle 2940

Private Bag x 6671, Newcastle 2940  
Tel: 034 312 8651 Fax: 034 312 8652

Enquires: Mr B.P Mbongwe  
Act SDM  
Amajuba  
03 February. 2023

Att: Supply chain Management

**REQUEST FOR A SAMPLE FROM THE SUPPLIER**

1. Above heading refers
2. Kindly consider our request as the end user of the uniform that the supplier who will be rewarded tender should provide us with the uniform sample (trouser ) before the process of finishing the order as to ensure that we both on the same satisfaction of what we require.
3. The trouser should match the top that we have as well as the texture of the uniform we have.
4. The supplier may also request the sample from us before the commencing with order awarded to him/her.

Thank you

.....  
Mr M.S Ndlovu  
Act-District Operations Manager  
Amajuba EMS

## UNIFORM B

DESCRIPTION	QUANTITY	UNIT PRICE	TOTAL
COVERALL 2 PIECE (SIZES ATTACHED)	96 PAIRS		
100% COTTON WHITE T-SHIRT  SIZES:  Small=15, Medium=70,  Large=40, XLarge=15,  2XLarge=15	155 UNITS		
80% COTTON anti static fibre HIGH BLACK SOCKS (One size fits all, which can fit size 5 to 11)	155 pairs		
SYNTHETIC & NATURAL MATERIAL SAFETY BOOTS (size 4=1, size 5=4, size 6=5,  size 7=11, size 8=6, size 9=2, size 10=2,  size 11=1)	32 pairs		
<b>TOTAL</b>			

## COVERALL 2 PIECE SIZES

### TOP

SIZE 30	9
SIZE 32	6
SIZE 34	30
SIZE 36	9
SIZE 38	15
SIZE 40	6
SIZE 42	3
SIZE 48	6
SIZE 157/147	3
SIZE 3XL	3
SIZE 117/102	3
<b>TOTAL</b>	<b>93</b>

### PANTS

SIZE 30	9
SIZE 32	3
SIZE 34	24
SIZE 36	9
SIZE 38	12
SIZE 40	6
SIZE 42	6
SIZE 48	3
157/147	3

44	3
50	3
117/102	3
97/87	6
92/82	3
<b>TOTAL</b>	<b>93</b>

[REDACTED] Forensic Pathology Services

Coveralls, two-piece

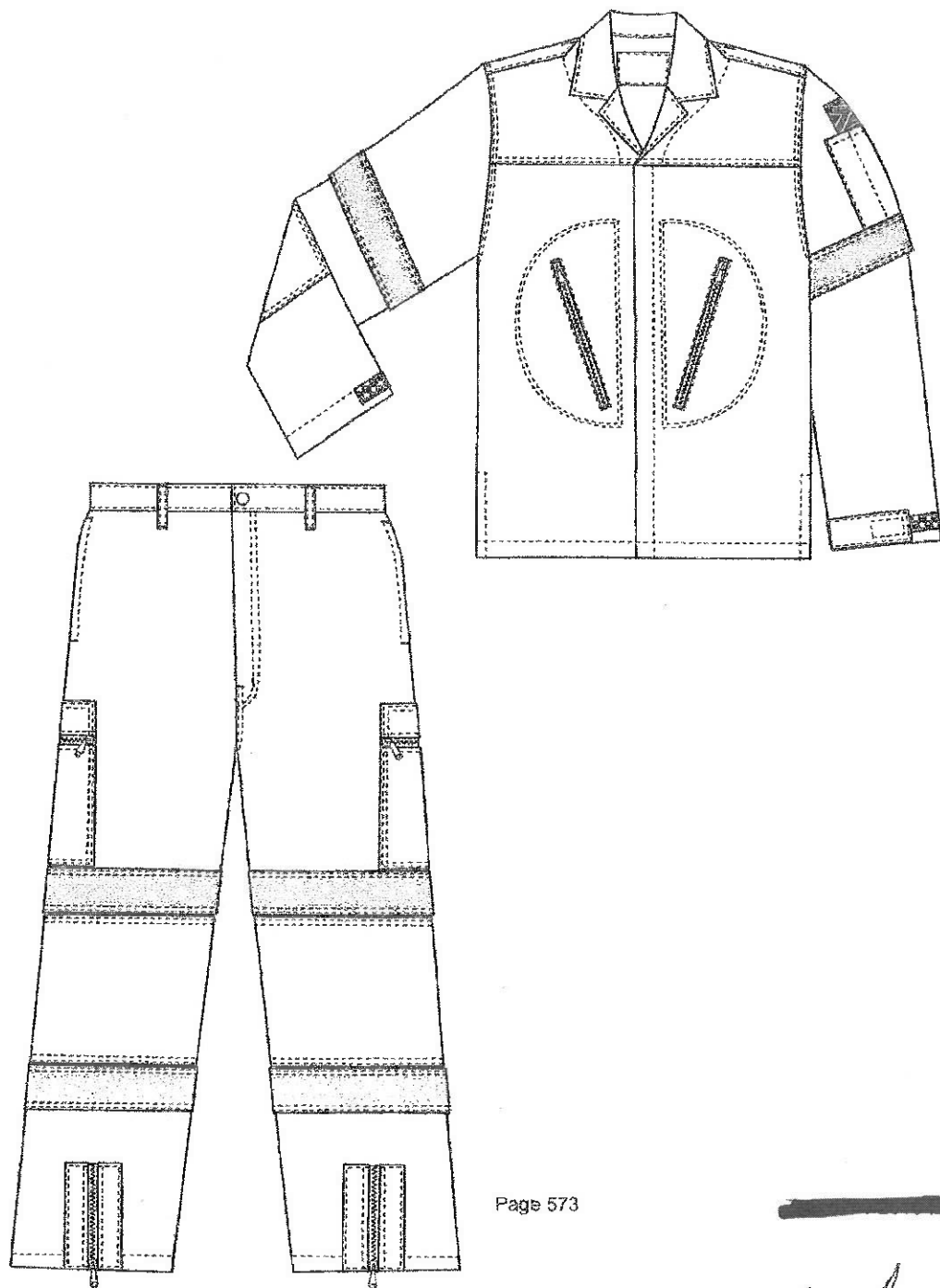

[REDACTED]  
*Handwritten signature*

## 1. Scope

This specification covers the materials and make of two-piece coveralls for members of the EMRS.

## 2. Style

### Jacket:

- ◆ front yoke and front facings
- ◆ front slide fastener opening covered with a fly
- ◆ slanted breast pockets (patch on inside of jacket)
- ◆ left front to have a multi-coloured embroidered design
- ◆ shoulder straps
- ◆ back to be plain with a multi-coloured embroidered design
- ◆ side slits
- ◆ open-neck with one-piece collar
- ◆ detachable long sleeves
  - with adjustable cuffs
  - with elbow reinforcement patches
  - fitted with reflective tape
  - fitted with an embroidered national flag on the left upper arm
  - fitted with a multi-coloured embroidered design on the right upper arm
  - fitted with one sleeve pocket on the left upper arm

### Trousers:

- ◆ front fly opening fitted with a slide fastener
- ◆ front to have a separate waistband that fastens with a button and buttonhole
- ◆ back waistband to be cut-on, fitted with elastic webbing and rucked with four rows of stitchings
- ◆ belt loops
- ◆ two side pockets with through openings with slide fastener closure
- ◆ two thigh pockets with slide fastener closure
- ◆ bottom leg openings
- ◆ two lengths of reflective tape sewn to each leg

## 3. Components

The following components shall be supplied by the manufacturer. The components as given in 3.2 to 3.8 shall be an acceptable match to the colour of the outer material (unless otherwise specified).

### 3.1 Outer Material

- ◆ 65% Polyester, 35% Viscose
- ◆ Std Mass: 200g
- ◆ Finish: Ruco Blood Repell
- ◆ Rip-Stop Weaved
- ◆ colour to be an acceptable navy blue colour as agreed upon between the purchaser and supplier



### 3.2 Touch and close fastener

- ♦ to comply with the requirements of SANS 1623
- ♦ nominal width of 25 mm
- ♦ Unnapped Fastener

### 3.3 Slide fasteners

- ♦ synthetic spiral
- ♦ fly opening, chest pocket opening, bottom leg opening, thigh pocket opening: one-way, closed end that complies with class B of SANS 1822
- ♦ front opening and sleeves: one-way, open end that complies with class B of SANS 1822
- ♦ thigh opening: one-way closed end that complies with class A of SANS 1822

### 3.4 Elastic webbing

- ♦ to comply with the requirements for type 1 of SANS 142 and of nominal width 45 mm

### 3.5 Reflective tape

- ♦ a high visibility retro-reflective silver tape
- ♦ of nominal width 50 mm
- ♦ retro-reflective properties to comply with the relevant requirements for a class 2 retro-reflective material of SANS 50741
- ♦

### 3.6 Embroidery thread

- ♦ an acceptable 100% viscose machine embroidery thread of various colours

### 3.7 Wadding

- ♦ an acceptable 100% polyester wadding

### 3.8 Threads

- ♦ to comply with relevant requirements of SANS 1362
- ♦ sewing thread: polyester-and-cotton core-spun or staple polyester, ticket No.
- ♦ overlocking thread: crimp textured polyester of polyamide, ticket No.





**4. Sizes**

The coveralls shall be supplied in the following sizes:

	Pattern Size	Jacket Size	Trouser Size	Jacket Chest Measurement		Trouser Seat Measurement		Inner Leg	Sleeve
XS	26	77	77/67	94	47	92	46	75	49
	28	82	82/72	99	49	97	48.5	79	49
S	30	87	87/77	104	52	102	51	80	49
	32	92	92/82	109	54.5	107	53.5	81	50
M	34	97	97/87	114	57	112	56	82	50
	36	102	102/92	119	59.5	117	58.5	82	50
L	38	107	107/97	124	62	122	61	82	50
	40	112	112/102	129	64.5	127	63.5	82	51
XL	42	117	117/107	134	67	132	66	81	51
	44	122	122/112	139	69.5	137	68.5	81	52
2XL	46	127	127/117	144	72	142	71	80	52
	48	132	132/122	149	74.5	147	73.5	80	53
3XL	50	137	137/127	154	77	152	76	80	53
	52	142	142/132	159	79.5	157	78.5	80	53
4XL	54	147	147/137	164	82	162	81	80	54
	56	152	152/142	169	84.5	167	83.5	80	54
5XL	58	157	157/147	174	87	172	86	80	54
	60	162	162/152	179	89.5	177	88.5	80	54

  
*Amund*

- edges to be double-stitched
- sewn in with the inside leg seams
- around full circumference of the legs
- ♦ fitted with a bottom leg opening
  - fitted with a 20 cm slide fastener
  - fitted with two outer material patches on both sides of the slide fastener, each of finished width 30 mm and edge-stitched
  - when slide fastener is closed, it shall reduce the bottom hem by 40 mm
- ♦ bottom hem to be 25 mm

#### 6.6 Seams

- ♦ all seams shall be double-stitched (except the inside leg seam)
- ♦ raw edges shall be over locked

#### 6.7 Embroidery

- ♦ Back Embroidery Logo: Forensic Pathology Services 22cm x 24.5cm
- ♦ Right Upper sleeve embroidery: KZN Health Logo 8.5cm x 9cm
- ♦ Front left chest embroidery: EMRS Number 49177 – 5.5cm x 10cm

#### 6.7.1 Embroidery

- ♦ Back Embroidery Logo: Forensic Pathology Services 22cm x 24.5cm
- ♦ Right Upper sleeve embroidery: KZN Health Logo 8.5cm x 9cm
- ♦ Front left chest embroidery: Forensic Pathology Services – 5.5cm x 10cm

*[Handwritten signature]*

## 6. Make

### 6.1 Jacket: Front



- ◆ to have a single yoke that shall be double-stitched along the yoke seam
- ◆ to have a lapel step of finished width 25 mm
- ◆ to have shaped front facings that shall extend from the shoulder seam to the front yoke seam
- ◆ front opening to be fitted with a slide fastener that shall extend from the yoke seam to 50 mm above the bottom hem
- ◆ left front edge to be cut-on and folded to the inside, forming a fly of finished width 30 mm
  - stitched down and concealing the slide fastener
- ◆ right front edge to be cut-on, folded to the inside forming a facing of finished width 50 mm
  - stringer shall be sewn to the front edge
- ◆ fitted with two slanted inside patch breast pockets
  - pocket bags of outer material
  - of finished front length 25 cm
  - of finished width 17 cm (measured in the centre)
  - outer edges to be double-stitched
  - pocket mouth to be slanted and fitted with a slide fastener of finished length 17 cm
- ◆ fitted with a multi-coloured embroidered design on the left front
- ◆ to have side slits of finished length 13 cm, stitched down
- ◆ fitted with shoulder straps that shall fasten with a button and buttonhole, sewn in with the sleeve insertion seam

### 6.2 Jacket: Back

- ◆ back to be plain with a multi-coloured embroidered design

### 6.3 Sleeves

- ◆ to be detachable inset sleeves
  - fitted with a slide fastener, concealed by a 30 mm overlap and fitted with a fly-catch of finished width 20 mm
- ◆ fitted with elbow reinforcement patches of outer material, interlined with wadding and double-stitched edges with the rear edges sewn in with underarm seams
- ◆ fitted with retro-reflective tape along the full circumference of the sleeve
  - side edges to be double-stitched
  - bottom edge to be positioned at the bottom edge of the slide fastener overlap
  - sewn in with the underarm seam
- ◆ right upper sleeve to be fitted with a multi-coloured embroidered design
- ◆ left upper sleeve to be fitted with a sleeve pocket of finished width and depth 90 mm and 13 cm respectively
  - to have a centre stitching, forming two compartments and bar-tacked at the mouth ends
  - positioned 70 mm below the crown of the sleeve
- ◆ left upper sleeve to be fitted with an embroidered national flag, positioned directly above the sleeve pocket (see below)
- ◆ outer cuffs to be fitted with adjustment straps of doubled outer material
  - sewn in width underarm sleeve
  - of finished length 13 cm
  - fitted with 25 mm male touch and close fastener
- ◆ cuff to be fitted with 25 mm female touch and close fastener
- ◆ cuff hem to be of finished width 30 mm

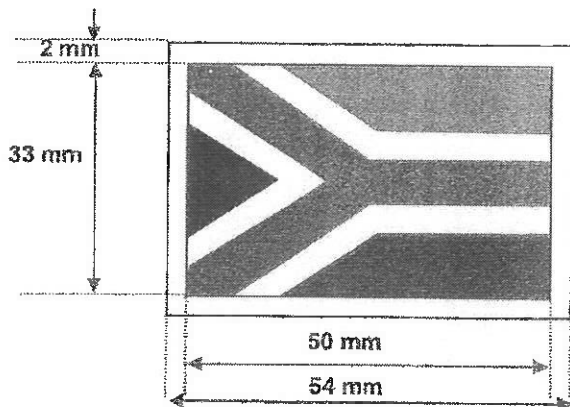

Colour section	Proportion	Width
Red	1/3	11.0 mm
Blue	1/3	11.0 mm
Green	1/5	6.6 mm
White	1/15	2.2 mm
Yellow	1/15	2.2 mm

#### 6.4 Collar

- ◆ one-piece open-neck shirt type collar
- ◆ edge-stitched
- ◆ of finished width 70 mm at the points and 80 mm at centre back

#### 6.5 Trouser

- ◆ front fly opening fitted with a slide fastener, double stitched and bar-tacked at the bottom edge
- ◆ front to have a separately cut waistband of finished width 40 mm that shall fasten with a button and buttonhole
- ◆ back waistband to be fitted with elastic webbing and rucked with four rows of stitching
- ◆ waist to be fitted with five belt loops of finished length 70 mm, two positioned on the front and three on the back
- ◆ to have two side pockets
  - positioned in the side seam, with the top edge 40 mm below the waistband seam
  - pocket bags of outer material
  - pocket mouth of finished length 18 cm and edge-stitched 10 mm
  - mouth ends to be bar-tacked
  - of finished width and depth 18 cm (measured below bottom bar-tack of pocket mouth)
- ◆ fitted with a through opening
  - positioned on inside of side pocket (same length as side pocket)
  - opening to be fitted with a slide fastener
  - fitted with a 20 mm double folded outer material fly-catch behind the stringers
- ◆ fitted with two thigh pockets
  - centrally positioned over the side seam
  - patch pockets of finished width 18 cm
  - of finished length 19 cm
  - pocket mouth to be of finished length 18 cm and fitted with a horizontally positioned slide fastener, 30 mm below the top edge of the pocket
  - edges to be double-stitched
- ◆ fitted with a knee reinforcement patch
  - of outer material, interlined with wadding
  - of finished depth 18 cm
  - laid on top of leg and top and bottom edges to be double-stitched
  - side edges to be sewn in with the side seams
- ◆ each leg to be fitted with two lengths of reflective tape
  - reflective tape to be positioned directly above and below the knee reinforcement patch

*[Handwritten signature]*

# FORENSIC PATHOLOGY SERVICES LOGO

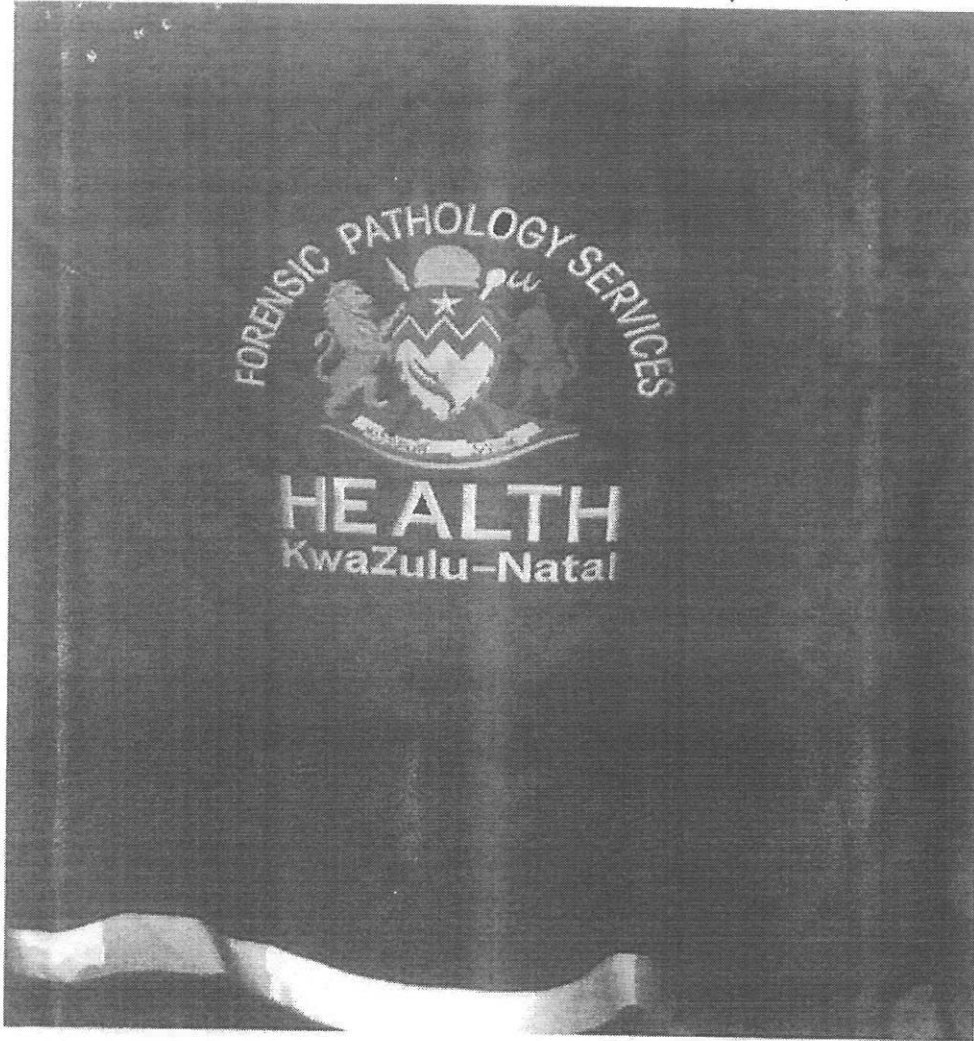

## Size Guide

WAIST REGULAR SIZE	CHEST OVERALL SIZE	
30		
32	36	S
34	38	M
36	40	M
38	42	L
40	44	XL
42	46	XXL
44	48	XXXL
46	50	XXXXL

*Account*

**Round Neck T-Shirt  
Collective Requirements**

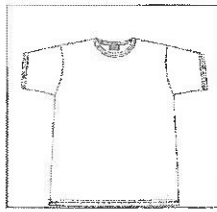

**Style Details**

- ❖ Plain Front
- ❖ Plain Back
- ❖ Round Neck With Binding
- ❖ Short Sleeves With Bound Cuff
- ❖ Straight Bottom Hem

**Front**

**Back**

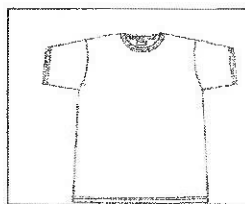

*[Handwritten signature]*

**Outer Fabric To:**

- ❖ Be An Acceptable Tubular Interlock Fabric That Complies With Type 165 Of Sans /50 "Interlock Fabric."
- ❖ Colour No. 1c --95 "White" Of CKS 129/21C "Colours For Textiles."

**Stay -Tape**

- ❖ Self Body Fabric
- ❖ Of Nominal Width 10mm

**Threads**

- ❖ To Comply With Relevant Requirements Of Sans 1362 "Sewing Threads"

**Sewing Thread**

- ❖ Polyester-And-Cotton Core-Spun
- ❖ Ticket No. 120

Measuring Point		Description
A-A	Chest Circumference	Measure At The Base Of The Scye, With Garment Spread Completely Flat, And Multiply By Two.
B-B	Back Length	Measure From The Centre Back Neck Seam To The Bottom Edge Of The Garment.
A-C	Sleeve Length	Measure Along The Underarm From The Base Of The Syce To The Bottom Edge Of The Cuff.
D-D	Neck Drop (Round Neck)	Measure From The Top Edge At The Centre Back Neck Point To The Top Edge At The Centre Front Neck Point.

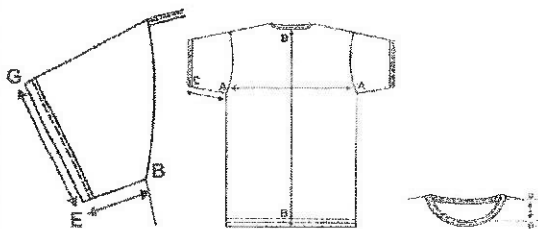

240..

ROUND NECK T-SHIRTS - WHITE

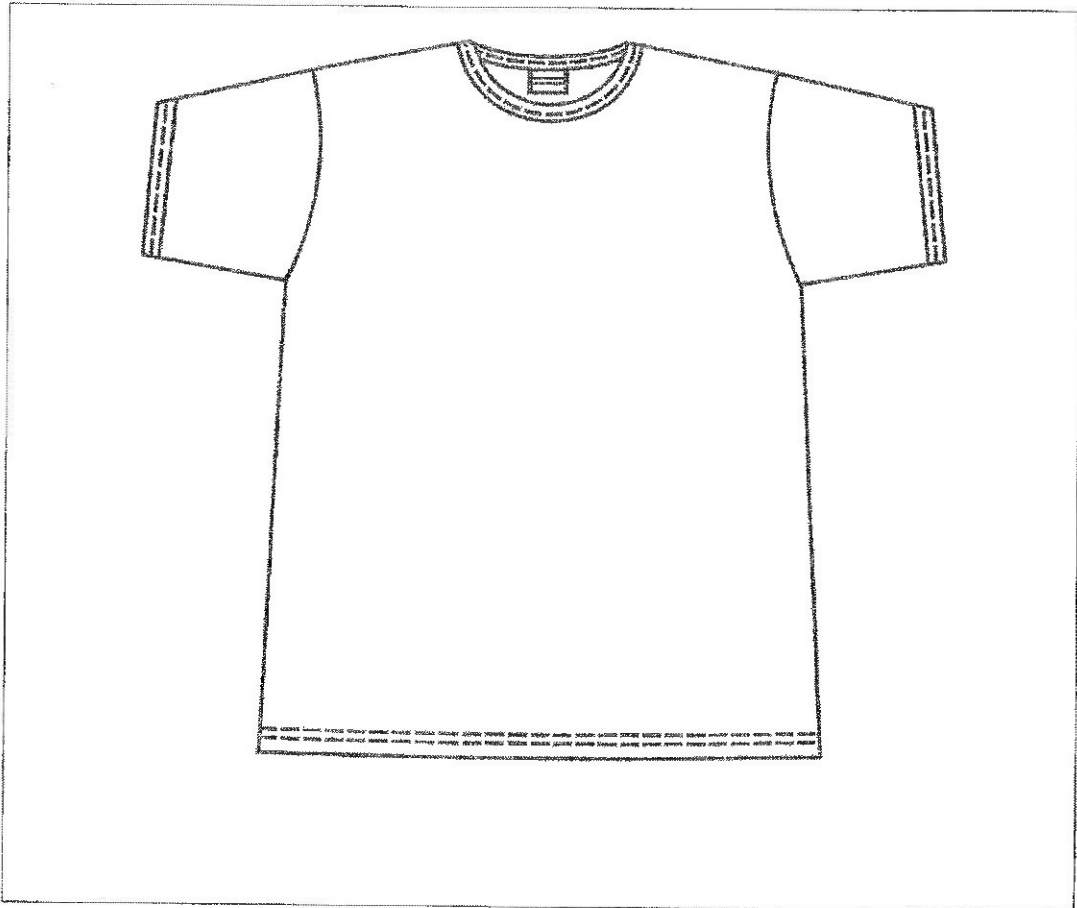

**STYLE DETAILS**

- ❖ PLAIN FRONT
- ❖ PLAIN BACK
- ❖ ROUND NECK WITH BINDING
- ❖ SHORT SLEEVES WITH BOUND CUFF
- ❖ STRAIGHT BOTTOM HEM

A handwritten signature in black ink, appearing to be 'R. M. S.', located below the style details list.



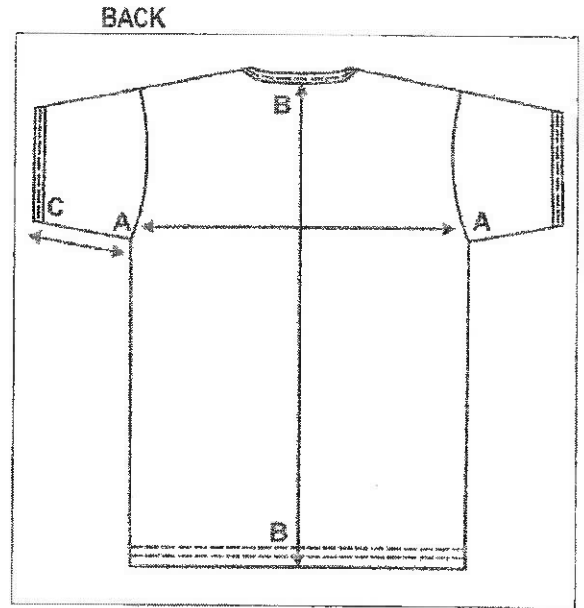
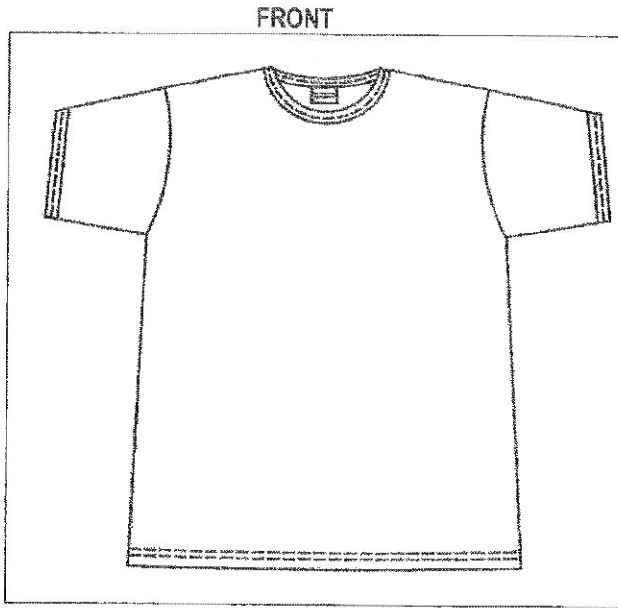

**OUTER FABRIC TO:**

- ❖ BE AN ACCEPTABLE TUBULAR INTERLOCK FABRIC THAT COMPLIES WITH TYPE 165 OF SANS 750 "INTERLOCK FABRIC."
- ❖ COLOUR NO. 1c – 95 "WHITE" OF CKS 129 "COLOURS FOR TEXTILES."

**STAY –TAPE**

- ❖ SELF BODY FABRIC
- ❖ OF NOMINAL WIDTH 10mm

**THREADS**

- ❖ TO COMPLY WITH RELEVANT REQUIREMENTS OF SANS 1362 "SEWING THREADS"

**SEWING THREAD**

- ❖ POLYESTER-AND-COTTON CORE-SPUN
- ❖ TICKET NO. 120

MEASURING POINT		DESCRIPTION
A-A	CHEST CIRCUMFERENCE	MEASURE AT THE BASE OF THE SCYE, WITH GARMENT SPREAD COMPLETELY FLAT, AND MULTIPLY BY TWO.
B-B	BACK LENGTH	MEASURE FROM THE CENTRE BACK NECK SEAM TO THE BOTTOM EDGE OF THE GARMENT.
A-C	SLEEVE LENGTH	MEASURE ALONG THE UNDERARM FROM THE BASE OF THE SYCE TO THE BOTTOM EDGE OF THE CUFF.
D-D	NECK DROP (ROUND NECK)	MEASURE FROM THE TOP EDGE AT THE CENTRE BACK NECK POINT TO THE TOP EDGE AT THE CENTRE FRONT NECK POINT.

*[Handwritten Signature]*



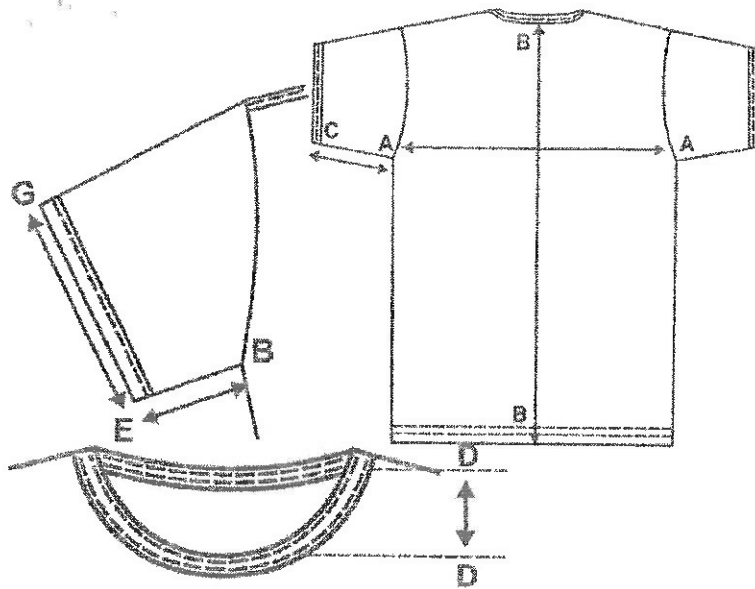

Table 1 - Size Chart					
1	2	3	4	5	6
National stock No.	Size designation	Nominal finished garment measurements,cm			
		Chest Circumference	Back length	Sleeve length (underarm)	Neck drop (round neck)
	X-Small (77-82)	80	72	13	7
	Small (87-92)	90	75	14	7
	Medium (97-102)	100	80	15	7
	Large (107-112)	110	82	16	7
	X-Large (117-122)	120	85	17	7

**BODY:**

- ❖ CONSISTS OF A SINGLE PIECE OF TUBULAR KNITTED FABRIC (I.E. WITH NO SIDE SEAMS)
  - MAY BE CUT WITH SIDE SEAMS AND OVERLOCKED TOGETHER.
- ❖ BE SHAPED AT THE NECK, ARMHOLES AND SHOULDERS
  - SHOULDERS OVERLOCKED TOGETHER
    - SHOULDER SEAMS STAYED WITH STAY-TAPE
    - BE SEWN IN WITH THE SHOULDER SEAM
- ❖ HAVE A 20mm COVER STITCH BOTTOM HEM.

**SLEEVE:**

- ❖ BE SHORT SET-IN SLEEVES
- ❖ BE OVERLOCKED TO THE BODY AND AT THE UNDERARM
- ❖ BE BOUND AT THE CUFF EDGE

*[Handwritten signature]*



- BINDING SHALL BE OF OUTER MATERIAL
- OF FINISHED WIDTH 12mm
- UNDERARM JOINING SEAM SHALL BE BAR-TACKED

**NECK OPENING:**

- ❖ BE ROUND SHAPED AND POSITIONED CENTRALLY ON THE FRONT
- ❖ BE BOUND
  - BINDING SHALL BE OF OUTER MATERIAL
  - OF FINISHED WIDTH 12mm
  - SHOULDER JOINING SEAM SHALL BE BAR-TACKED

**PACKING:**

**THE T-SHIRT SHALL BE:**

- ❖ DELIVERED IN A COMMERCIAL DRY CONDITION
- ❖ SO PACKED THAT THEY WILL NOT BE DAMAGED IN TRANSIT OR IN STORAGE
- ❖ NEATLY FOLDED AND INDIVIDUALLY PACKED IN A PLASTIC ENVELOPE OF A SUITABLE SIZE AND SHAPE IN SUCH A WAY THAT THE GARMENT LABEL DETAILS ARE CLEARLY VISIBLE

**CARE-LABELLING**

- ❖ EACH GARMENT TO HAVE A WOVEN OR PRINTED LABEL THAT IS PERMANENTLY SECURED AND THAT PROVIDES (IN ACCORDANCE WITH SANS 10011 "CARE LABELLING FOR TEXTILES AND CLOTHING") CORRECT AND APPROPRIATE CARE INSTRUCTIONS AND THE FIBRE COMPOSITION OF THE FABRIC (IN ACCORDANCE WITH THE REQUIREMENTS OF SANS 10235 "FIBRE – CONTENT LABELLING OF TEXTILES AND TEXTILE PRODUCTS)
- ❖ PRINTED LABELS TO COMPLY WITH THE REQUIREMENTS OF SANS 1309 "PRINTED LABELS FOR TEXTILES"
- ❖ ALL CARE-LABELS AND THEIR MARKINGS TO BE SUCH THAT THEY OUTLAST THE GARMENTS.

**SAFETY BOOT: FORENSIC PATHOLOGY SERVICES**

**DESCRIPTION:**

The footwear must be made with both synthetic and natural materials that conform to the relevant sections of either EN ISO 20345:2011 or EN ISO 20347:2012 for performance and quality. The relevant standards should be marked on the tongue label. The safety footwear should comply with the EC Directive for Personal Protective Equipment (Directive 89/686/EC) and meets the requirements of SABS/ European Standards.

It should be designed to protect the wears toes against risk of injury from falling objects and crushing when worn in industrial and commercial environment. This footwear must be tested against EN ISO 20345:2011 clause 5.3.5 for slip and heat resistance. It must be designed for the harshest environments, this lightweight boot feels like you are wearing a sneaker, but still provides support and durability required for a uniform boot.

**APPLICATION:**

- ❖ Law Enforcement, Forensic Pathology Services, Outdoor

**STYLE:**

- ❖ YKK side Zipper / Circular side zipper



## **SAFETY BOOT: FORENSIC PATHOLOGY SERVICES**

### **DESCRIPTION:**

The footwear must be made with both synthetic and natural materials that conform to the relevant sections of either EN ISO 20345:2011 or EN ISO 20347:2012 for performance and quality. The relevant standards should be marked on the tongue label. The safety footwear should comply with the EC Directive for Personal Protective Equipment (Directive 89/686/EC) and meets the requirements of SABS/ European Standards.

It should be designed to protect the wears toes against risk of injury from falling objects and crushing when worn in industrial and commercial environment. This footwear must be tested against EN ISO 20345:2011 clauses 5.3.5 for slip and heat resistance. It must be designed for the harshest environments, this lightweight boot feels like you are wearing a sneaker, but still provides support and durability required for a uniform boot.

### **APPLICATION:**

- ❖ Law Enforcement, Forensic Pathology Services, Outdoor

### **STYLE:**

- ❖ YKK side Zipper / Circular side zipper
- ❖ Breathable material and water resistant upper
- ❖ Moisture-wicking talbrelle lining keep feet dry
- ❖ EVA midsole for comfort shock absorption
- ❖ Heel stabilizer, channel stitched heel toe for added strength
- ❖ Steel shank for stability
- ❖ Carbon rubber outsole for durability
- ❖ Slip & oil resistance
- ❖ Multiple impact composite safety toecap
- ❖ Charged heel air cell



- ❖ Slip & oil resistance
- ❖ Multiple impact composite safety toecap
- ❖ Charged heel air cell

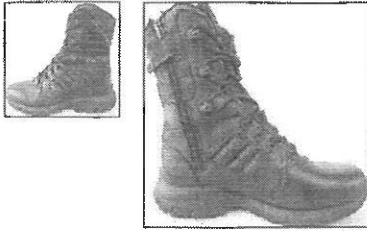

**SIZE GUIDES:**  
Women's/Men's Footwear

U.K.	Europe
5	38
6	39
7	41
8	42
9	43
10	44
11	45
12	46
13	47

*Handwritten scribble*

**COVERALLS - TWO PIECE**

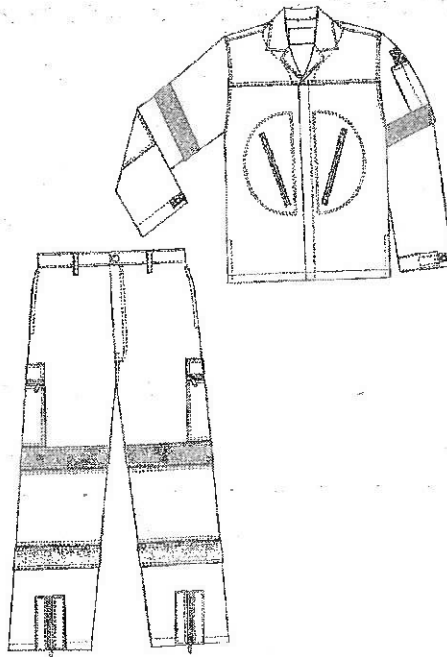

*Handwritten signature*

## EVALUATION CRITERIA over R30 000.

Proposals received shall be evaluated on the following.

### 1. Specification

Only offers that meet the specification in all aspects as stipulated in the bid document shall be considered. Offers better than specification are considered to be compliant with the specification.

### 2. Correctness of information

All information required in the bid document must be accurate and dully completion including all the appropriate signatures. This include the completion of documentation where required and the submission of required / requested documentation e.g. Valid Tax Certificate, etc. Able to adhere to time frame (delivery/service period must be clearly indicated). Please ensure samples of products submitted is of good quality and free from infestations (moth & food insects) and in sealed tins. The institution reserves the right to verify all information submitted.

### 3. Preferential Points System

3.1 The 80/20 preferential point system shall be used in the evaluation process

B-BBEE Status Level of contributor	Number of points (80/20 system company to ring their level)
1	20
2	18
3	16
4	12
5	8
6	6
7	4
8	2
Non-compliant contributor	0

### 4. Specific Goals

4.1 Over and above the following activities will be considered in the evaluation/ adjudication process.

4.2

- (i) Whether the quotation offers value for money
- (ii) Compulsory registration of the Provincial Suppliers Database
- (iii) SABS approved products
- (iv) As per specification/description
- (v) All warranties/guaranties to be supplied with the product when delivery is made
- (vi) Verification the recommended bidder is not on the Register for tender defaulters
- (vii) Verification of the identity numbers of the directors/trustees/shareholders of the preferred bidder(s) against the institution's staff establishment in order to determine whether or not any of the directors/trustees/shareholders are in the service of the State or officials employed by specific institution

## 5. Execution Plan

5.1 If the bidder is a supplier not a manufacturer of the output tendered for, he/she must submit with the bid document on closing date and time of a bid, a guarantee from a manufacturer that support required to execute the contract will be successfully. Please attach a guarantee from a manufacturer as part of the bid document. **NB:** If you are manufacture or keeping the items/goods on the shelf, please attach the confirmation as a proof.

**OR**

If the bidder is a supplier (middle man) not keeping the product (item) directly on/in their shelves/shop, he or she must submit with the bid document on closing date and time of a bid, a guarantee letter from the supplier that support required to execute the contract will be successfully, a letter from the suppliers, a letter can include the product name and mention that item is fully compliant with specification . Please attach a letter from a supplier as part of the document.

This evaluation criteria is designed in such a way that responses would be required from the bidders, **NB:** Failure to submit the required documents(s) may invalidate the entire bid.

This evaluation criteria is designed in such a way that responses would be required from the bidders, **NB:** Failure to submit the required documents(s) may invalidate the entire bid.

**PLEASE SIGN AND RETURN THE EVALUATION CRITERIA WITH THE QUOTATION FORM AND RELEVANT DOCUMENTS**

\_\_\_\_\_  
**NAME & SURNAME**

\_\_\_\_\_  
**SIGNATURE**